

1/6

The
SHORTWAVE
Magazine

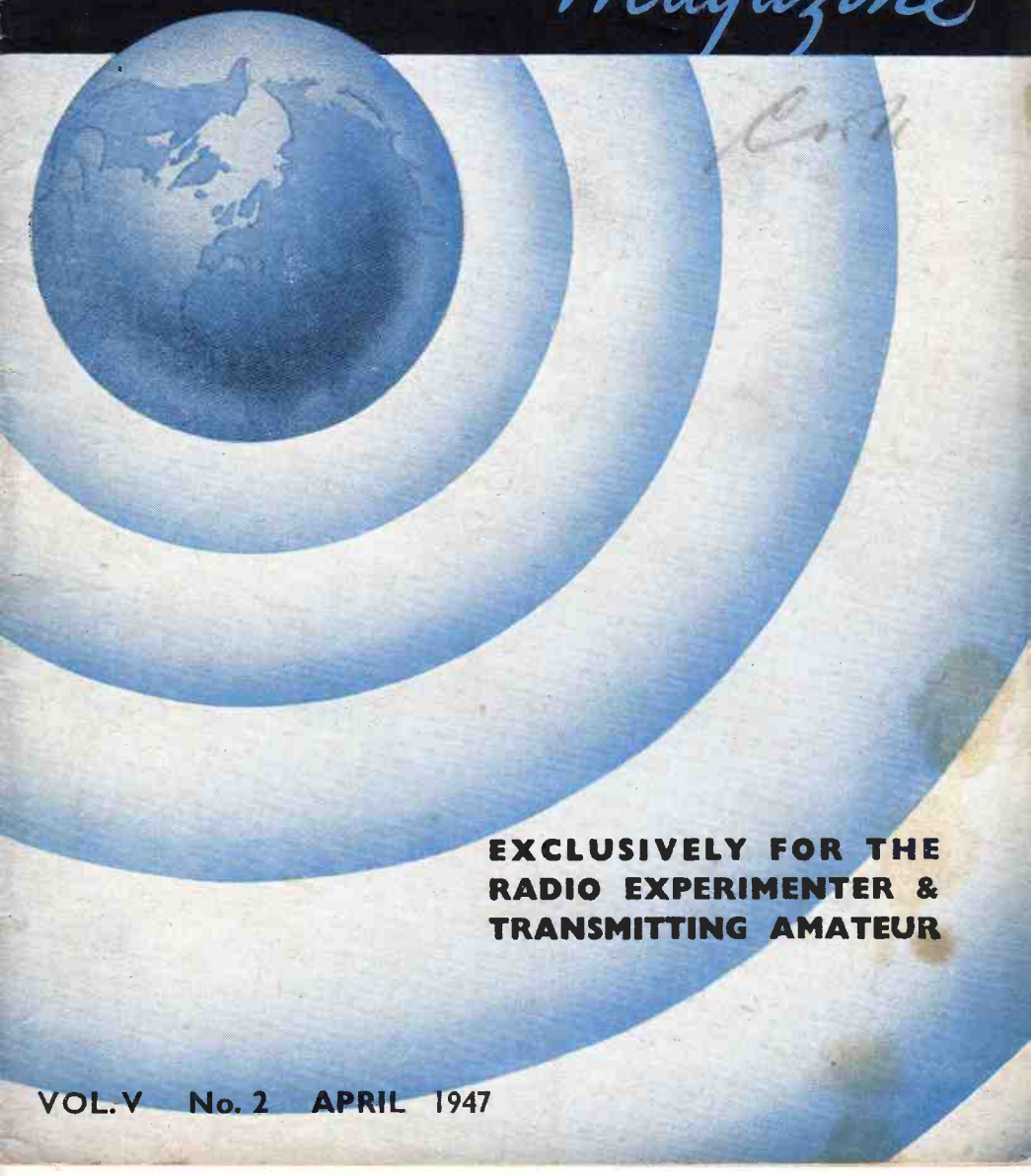

**EXCLUSIVELY FOR THE
RADIO EXPERIMENTER &
TRANSMITTING AMATEUR**

VOL.V No. 2 APRIL 1947

Everything for the AMATEUR TRANSMITTER

WEBB'S Radio

HIGH-VOLTAGE CONDENSERS

NEUTRALISING CONDENSERS

TUNING CONDENSERS

AERIAL EQUIPMENT

POWER RESISTORS

POWER CHOKES

TRANSFORMERS

VALVES

METERS

CRYSTALS

INSULATORS

COILS & KEYS

RACK EQUIPMENT

Webb's are Britain's leading specialists in Radio for the serious experimenter. Staffed by practical men who, being transmitting amateurs themselves, can talk your language and give you the advice and co-operation you need. Everything sold is covered by Webb's unconditional guarantee of satisfaction.

The HUB of the HAM World



14 SOHO ST., OXFORD ST., LONDON, W.1. Phone: GER. 2089

WORKED ALL ZONES

Following are the boundaries of the 40 Zones into which the world has been divided for the purpose of measuring DX achievement. This list has been carefully checked in the light of the latest information. WAZ is based upon the pre-war DX yardstick first suggested by the American publication *Radio*, to which *CQ* is the post-war successor. We acknowledge the latter as the source of our inspiration on this particular matter.

It has been agreed between the Editors of *CQ* and the *Short Wave Magazine* that we accept, and publish in "DX Commentary," all G claims for WAZ. These British listings will be reprinted in *CQ's* "WAZ Honour Roll."

In the next (May) issue of the *Short Wave Magazine* will appear a great circle map of the world centred on London. This map will have the Zones marked in, and within the limitations of its scale will give magnetic bearings and rough distances from London of all points on the earth's surface. The map will be printed in the *Magazine* as a two-page spread, and an enlarged version, suitable for wall mounting, will be available in due course. Further details about this will appear in the May issue.

Zone 1—Northwestern Zone of North America	Zone 7—Zone of Central America	Zone 14—Western Zone of Europe
Alaska KL7	Honduras HR	Portugal CT1
Yukon (part of) VE8	British Honduras VP1	Spain EA
Canadian Northwest Territories (part of) VE8	Guatemala TG	Andorra PX
District of Mackenzie VE8	Costa Rica TI	France F
District of Franklin VE8	Nicaragua YN	Nicaragua HB
Islands west of 102° W., including Victoria, Banks, Melville, and Prince Patrick.	Panama HP	Belgium LN
	Canal Zone KZ5	Luxembourg ON
Zone 2—Northwestern Zone of North America	Zone 8—West Indies Zone	Saar EZ
Canada, that portion of Quebec (part of VE2) north of an east and west line drawn along and extended from the southern boundary of Labrador.	Cuba CM	Germany (except East Prussia) D
Canadian Northwest Territories (part of) VE8	Puerto Rico KP4	Denmark OZ
District of Keewatin	Virgin Islands KV4	Sweden SM
District of Franklin east of Long, 102° W., including Islands of King William, Prince of Wales, Somerset, Bathurst, Devon, Elsmere, Baffin, and the Melville and Boothia Peninsulas.	Cayman Islands, Jamaica, Turk's & Caicos Is. VP5	Norway LA
Zone 3—Western Zone of North America	Bahamas VP7	Great Britain G
British Columbia (part of VE7)	Barbados VP6	North Ireland GI
W7 except Wyoming and Montana	Haiti HH	Scotland GM
All W6.	Dominican Republic HI	Wales GW
Zone 4—Central Zone of North America	Dominica, St. Lucia, Antigua, St. Kitts-Nevis VP2	Channel Islands GC
All VE3, VE4, VE5, VE6	Guadeloupe FG8	Irish Free State EI
W5, W9 and W0	Martinique FM8	Netherlands (Holland) PA
Wyoming and Montana (part of W7)	All Greater and Lesser Antilles except Bermuda and those listed in Zone 9	Azores Islands CT2
Ohio (part of W8)		Faroes Islands OY
Tennessee, Alabama and Kentucky (part of W4)	Zone 9—Northern Zone of South America	Gibraltar ZB2
Zone 5—Eastern Zone of North America	Colombia HK	Zone 15—Central Zone of Europe
All VE1, VO, W1, W2, W3.	Venezuela YV	Italy I
VE2 (Quebec) south of line mentioned in Zone 2	Dutch Guiana PZ	Albania ZA
W4 except Tennessee, Alabama, and Kentucky	French Guiana FY	Austria OE
W8 except Ohio	British Guiana VP3	Liechtenstein HE
Bermuda VP9	Trinidad VP4	Poland SP
Swan Is. KD4	Curacao PJ	Finland OH
Zone 6—Southern Zone of North America	Tobago VP4	Latvia UO2
Mexico XE	Grenada VP2	Lithuania UP
	Zone 10—Central Zone of South America	Estonia UR1
	Ecuador HC	Czechoslovakia OK
	Peru OA	Yugoslavia YU
	Bolivia CP	Corsica SV
	Colon or Galapagos Archipelago HC	Sardinia
	Zone 11—East Central Zone of South America	Hungary HA
	Brazil PY	Malta ZB1
	Paraguay ZP	Sicily I
	Zone 12—Southwestern Zone of South America	San Marino
	Chile CE	Polish East Prussia
	Zone 13—Southeastern Zone of South America	Zone 16—Eastern Zone of Europe
	Argentina LU	European portions of U.S.S.R. including European portion of Soviet Russia, White Russia, Ukraine, and Novaya Zemlya. UA1, UN1, UC2, UA3, UA4, UB5, UB6, UD6, etc.
	Uruguay CX	Zone 17—Western Siberian Zone of Asia
	Falkland Island VP8	Asiatic U.S.S.R. UJ8, UA9, etc.
	South Shetland Islands VP8	Uzbek
	Georgia Island VP8	Ural
		Kirghiz Kara Kalpak
		Tadzhik Kazak
		Turkmen

Zone 18—Central Siberian Zone of Asia		Zone 26—Southeastern Zone of Asia		Zone 33—Northwestern Zone of Africa	
Buryat Mongol	UAØ	Burma	XZ	French Morocco	CN8
Oyrat		Siam	HS	Spanish Morocco	EA9
Siberian Krai (Eastern and Western)		French Indo-China	FI	Rio de Oro	
		Andaman Islands	VU	Tunisia	FT4
Zone 19—Eastern Siberian Zone of Asia		Zone 27—Philippine Zone		Algeria (Northern and Southern)	FA
Yakutsk	UAØ	Philippine Archipelago	KA	Ifni	
Far Eastern Area or Dalnevostchnyi		Guam	KG6	Madeira	CT3
		Yap		Canary Islands	EA8
Zone 20—Balkan—Asia Minor Zone		Caroline Islands		Zone 34—Northern Zone of Africa	
Rumania	YR/YO	Mariana Islands	KB6	Libya	LI, T1, TR
Bulgaria	LZ	Islands east of Philippines, west of Long. 163° E., north of Lat. 2° N., and south of a line from 153° E., 40° N. to 131° E., 23° N.		Egypt	SU
Greece	SV			Anglo-Egyptian Sudan	ST
Crete	SV	Zone 28—Malayan Zone of Asia		Zone 35—Western Zone of Africa	
Aegean Islands	SV	Malay States (Federated and Non-Federated)	VS2	French West Africa	FF8
Syria	AR	Johore		Nigeria	ZD2
Palestine	ZC6	Straits Settlements	VS1	Ivory Coast	ZD4
Transjordania	ZC1	Malay Archipelago, including Netherlands Indies (Dutch East Indies)		Gambia	ZD3
Cyprus	ZC4	Java	PK	Cape Verde Islands	CR4
Zone 21—Southwestern Zone of Asia—Saudi Arabia		Sumatra	PK4	French Guinea	
Saudi Arabia (Hedjaz, Nedj)	HZ	British North Borneo	VS4	Liberia	EL
Yemen		Sarawak	VS5	Portuguese Guinea	CR5
Oman		Papua	VK4	Dahomey	
Aden	VS9	New Guinea	VK9	Ashanti	
Asir		Borneo	PK5	Sierra Leone	ZD1
Iraq (Mesopotamia)	YI	Solomon Islands	VR4	Senegal	
Afghanistan	YA	Timor Islands	CR10	Gold Coast	ZD4
Persia (Iran)	EP	Portuguese East Indies	CR8	French Sudan	FD8
India (Baluchistan only)	VU	Islands between Lat. 2° N. and 11° S., and west of Long. 163° E.		Togoland	FD8, ZD4
U.S.S.R. (Transcaucasia only, Georgia, Armenia, Azerbaijan)	UB6, UD6, etc.	Zone 29—Western Zone of Australia		Zone 36—Equatorial Zone of Africa	
Kuwait		Australia	VK	Angola (Portuguese West Africa)	CR6
Bahrein Island	VS8, VU7	Western Australia		Cameroons	FE8
Zone 22—Southern Zone of Asia		North Australia		Spanish Guinea	
India (except Baluchistan and Burma)	VU	Central Australia		French Equat. Africa	FQ8
Assam		Zone 30—Eastern Zone of Australia		Belgian Congo	OQ5
Sikkim	AC3	Australia	VK	Northern Rhodesia	VQ2
Ceylon	VS7	Queensland		Cabinda	
Nepal		New South Wales		Rio Muni	
Mahe		Victoria		Gabon	
Maldiv Islands	VS9	Tasmania	VK7	St. Helena Island	ZD7
Laccadive Islands	VS9	South Australia		Ascension Island	ZD8
Karikal		Islands south of Lat. 11° S. and west of Long. 153° E.		Zone 37—Eastern Zone of Africa	
Bhutan	FN	Zone 31—Central Pacific Zone		Mozambique (Portuguese East Africa)	CR7
Pondicherry	CR8	Hawaiian Islands	KH6	British East Africa	
Goa		Ellice Islands	VR1	Kenya	VQ4
Zone 23—Central Zone of Asia		Gilbert Islands	VR1	Uganda	VQ5
Chinese Republic, following portions only:	CXU)	Baker, Howland, American Phoenix Islands	KB6	Tanganyika	VQ3
Tibet	AC	Midway	KM6	Nyasaland	ZD6
Sinkiang (Chinese Turkestan)		Palmyra Group, Jarvis	KP6	Ethiopia (Abyssinia)	ET
Tannu Tuwa (Tannou Touva)		Wake Island Group	KW6	Italian Somaliland	
China Proper (Kansu province only)		Johnson	KJ6	British Somaliland	VQ6
Outer Mongolia		Islands between Lat. 11° S. and 40° N., and between Long. 163° E. and 140° W.		French Somaliland	FL8
Inner Mongolia (except Chahar Province)		Zone 32—New Zealand Zone		Eritrea	16
Zone 24—Eastern Zone of Asia		New Zealand	ZL	Zanzibar Island	
China Proper (except Kansu Province)		Loyalty Islands		Socotra Islands	
Inner Mongolia (Chahar Province only)		Tahiti	FO	Mafia Islands	
Manchukuo (Manchuria)	MX	Fiji	VR2	Zone 38—Southern Zone of Africa	
Kwangchow		New Hebrides	FU8, YJ	Union of South Africa	ZS
Macao	CR9	Samoa	KS6	Southern Rhodesia	ZE
Hong Kong	VS6	New Caledonia	FK8	Swaziland	ZS
Darien		Pitcairn Islands	VR6	Basutoland	ZS4
Japan (Taiwan or Formosa only)	J9	Chatham Islands		British Southwest Africa	ZS3
Zone 25—Japanese Zone of Asia		Islands south of Lat. 11° S. and between Long. 163° E. and 120° W.		Bechuanaland	ZS
Japan (except Taiwan or Formosa)	J	Zone 33—Northwestern Zone of Africa		Tristan de Cunha Isl'd	ZD9
Chosen (Korea)	J8	French Morocco	CN8	Gough Island	
		Spanish Morocco	EA9	Bouvet Island	
		Rio de Oro		Zone 39—Madagascar Zone	
		Tunisia	FT4	Madagascar	FB8
		Algeria (Northern and Southern)	FA	Reunion Island	FR9
		Ifni		Seychelles Island	VQ9
		Madeira	CT3	Admirante Island	
		Canary Islands	EA8	Mauritius Island	VQ8
		Zone 34—Northern Zone of Africa		Zone 40—North Atlantic Zone	
		Libya	LI, T1, TR	Greenland	OX
		Egypt	SU	Iceland	TF
		Anglo-Egyptian Sudan	ST	Svalbard (Spitzbergen)	
		Zone 35—Western Zone of Africa			
		French West Africa	FF8		
		Nigeria	ZD2		
		Ivory Coast	ZD4		
		Gambia	ZD3		
		Cape Verde Islands	CR4		
		French Guinea			
		Liberia	EL		
		Portuguese Guinea	CR5		
		Dahomey			
		Ashanti			
		Sierra Leone	ZD1		
		Senegal			
		Gold Coast	ZD4		
		French Sudan	FD8		
		Togoland	FD8, ZD4		
		Zone 36—Equatorial Zone of Africa			
		Angola (Portuguese West Africa)	CR6		
		Cameroons	FE8		
		Spanish Guinea			
		French Equat. Africa	FQ8		
		Belgian Congo	OQ5		
		Northern Rhodesia	VQ2		
		Cabinda			
		Rio Muni			
		Gabon			
		St. Helena Island	ZD7		
		Ascension Island	ZD8		
		Zone 37—Eastern Zone of Africa			
		Mozambique (Portuguese East Africa)	CR7		
		British East Africa			
		Kenya	VQ4		
		Uganda	VQ5		
		Tanganyika	VQ3		
		Nyasaland	ZD6		
		Ethiopia (Abyssinia)	ET		
		Italian Somaliland			
		British Somaliland	VQ6		
		French Somaliland	FL8		
		Eritrea	16		
		Zanzibar Island			
		Socotra Islands			
		Mafia Islands			
		Zone 38—Southern Zone of Africa			
		Union of South Africa	ZS		
		Southern Rhodesia	ZE		
		Swaziland	ZS		
		Basutoland	ZS4		
		British Southwest Africa	ZS3		
		Bechuanaland	ZS		
		Tristan de Cunha Isl'd	ZD9		
		Gough Island			
		Bouvet Island			
		Zone 39—Madagascar Zone			
		Madagascar	FB8		
		Reunion Island	FR9		
		Seychelles Island	VQ9		
		Admirante Island			
		Mauritius Island	VQ8		
		Zone 40—North Atlantic Zone			
		Greenland	OX		
		Iceland	TF		
		Svalbard (Spitzbergen)			

CALLS HEARD

Please arrange all logs strictly in the form given here, in numerical and alphabetical order and on separate sheets under appropriate headings, with callsign and address on each sheet.

14 mc

OVERSEAS

Harold Owen, B.Sc., West African
Cacao Research Institute, Tafo,
Gold Coast Colony.

1.7 mc

Alois Weirauch, OK1AW, Mestec
Kralove 9, Czechoslovakia.

G2FSR, 2FSG, 2JF, 2IX, 2MI
2WQ, 3AFZ, 4AL, 4CF, 5MY, 5PR,
5RI, 5ZX, 6GM, 8VN, 8WF,
GM3AWF, GW8WJ. (March 2,
0250-0300 GMT.)

7 mc

Harold Owen, B.Sc., West African
Cacao Research Institute, Tafo,
Gold Coast Colony.

CW: G2TA (35), 5GK (55), 5HQ
(33), 8TK (34), G16TK (55).
(February 2-15: RS values in
brackets: all T9, Receiver: 0-V-1.)

CW: D2GQ (578), EI9N (55),
G2ABR (55), 2ALH (448), 2AVP
(55), 2BAB (46), 2BMC (55), 2BOC
(56), 2CLL (56), 2COP (56), 2DML
(44), 2DPD (56), 2DFD (57),
2FGX (55), 2FMM (56), 2FRV(32),
2HFO (56) 2IM (577), 2IO (468),
2KG (55), 2LU (548), 2MI (56),
2NM (578), 2PQ (57), 2QY (567),
2TA (34), 2WW (45), 3AAK (448),
3ACC (56), 3ACP (46), 3AOS (558),
3APK (33), 3APO (43), 3APX (33),
3ASG (56), 3ATK (44), 3BLG (55),
3CC (558), 3FC (448), 3HK (45),
3IH (55), 3IQ (56), 3IR (55),
3LP (56), 3PZ (568), 3SR (56),
3VA (55), 3VP (44), 3WL (55),
3WR (55), 3YT (468), 4BB (55),
4CP (45), 4IN (56), 4JB (55),
4KI (568), 4KS (56), 4LO (448),
5CV (56), 5DQ (567), 5DV (55),
5FF (56), 5GT (55), 5JU (56),
5LI (558), 5LP (56), 5NV (56),
5PJ (44) 5SK (55), 5VB (568),

5WM (578), 5YU (588), 5YV (567),
6AH (43) 6BS (558), 6CL (558),
6HL (57), 6JF (57), 6KP (56),
6LH (45), 6NB (578), 6QN (55),
6QX (447), 6RS (55), 6UA (56),
6WI (568), 6ZQ (568), 8FC (44),
8FF (45), 8FN (53), 8GP (56),
8HH (44), 8II (56), 8JR (44),
8KA (558), 8KH (54), 8NF (57),
8ON (55), 8RL (54), 8UD (56),
8UG (458), 8UK (348), 8UT (557),
8VR (448), 8VV (44), G15UR (568),
5UW (45), 6TK (56), 6YM (55),
GM3BHU (34), 3RL (577), 6IS (44),
6J (568), 6MD (45), 6RI (56),
GW2FGJ (34), 3VL (54).
(February 1-28: RS values in
brackets; T9 unless otherwise
stated. Receiver: 0-V-1.)

FIVE METRES

G5BY, Resthaven Hotel, Thurle-
stone, Nr. Kingsbridge, Devon.

Worked: G2XC, 3APY, 5US,
8JV, 8VV.

Heard: G2MR (335), 2MV (557),
2NH (334), 3IS (334), 4AJ (334),
6LK (568), 6VA (334), 6YU (335).
(All during "Aurora" evening,
March 8: RST in brackets.)

G5MR, South Lawn, Admiralty
Road, Felpham, Bognor Regis,
Sussex.

Worked: G2MR, 2MV, 2NM,
2XC, 2YL, 4IG, 5MA, 6FO, 6LK,
6FH, 6VA, 8JB.

Heard: G3PW, 4AJ, 5BD, 5US,
6NA, 6YU, 8TS. (All during
February 8-March 9.)

QSL BUREAU RULES

- (1) Use of the Bureau both ways is open only to readers who obtain either the *Short Wave Listener* or the *Short Wave Magazine* from us on direct subscription. Cards from overseas are, however, accepted without restriction for free delivery to any British amateur.
- (2) The Bureau can only handle cards for amateur stations and is prepared to accept them for amateurs throughout the world.
- (3) Cards should be forwarded to us in fully stamped envelopes addressed BCM/QSL, London, W.C.1. This is a full and sufficient address from any part of the world.
- (4) When sending the first batch of cards, enclose three stamped self-addressed envelopes of a suitable size for return QSL's.
- (5) All such return envelopes must be marked "QSL Bureau" in the top left-hand corner.
- (6) No communications of any kind, other than the cards, return envelopes and certain printed forms that will be supplied to users, should be contained in packets addressed to the QSL Bureau.
- (7) Cards inwards to the Bureau can be forwarded as frequently as may be desired. Cards outwards to Bureau users will be cleared fortnightly.

EDDYSTONE'S NEW SPEAKER

They have just produced an extremely smart, well-finished little PM speaker which is ideal for a communications receiver. The impedance is 3 ohms, and the audio output is ample off the average receiver—we tested the speaker with an AR77, an HRO, an SX24 and an S27. Sizes overall are 5-in. diameter by 3-in. deep, and a reasonable length of connector lead is provided. Of all Eddystone dealers, price 67s. 6d. complete.

OPPOSITE SEX

There are so many of them in the States that our American contemporary CQ is able to run several columns each month entitled "The YL's Frequency," complete with suitable photographs, DX news items, cracks at the opposite sex, and its own conductress, WINPUP.

We know of five active YL operators with G calls. There must be more. Would they like to recognise themselves to us, not for publicity, but just for the record?

First Class Operators' Club

Gerald Marcuse, G2NM, Elected President

We are particularly pleased to be able to announce that, by unanimous vote of the membership, G2NM has been elected President of the F.O.C. Members may well be proud of the fact that Gerald Marcuse—the G.O.M. of Amateur Radio, as honoured in America as he is in this country, with a call sign he made famous twenty years ago—has accepted the office and so becomes their first President in the post-war period.

It is hardly necessary for us to chronicle the achievements of G2NM, nor the distinctions they have brought him in the world of Amateur Radio, in which he was one of the pioneers. Suffice it to say that G2NM remains as keen an amateur now and as active on the air as ever he was—indeed, there are not many operators in this country to-day who, like G2NM, can be heard on all bands from 1.7 to 58 mc. And there are even fewer who have done as much for Amateur Radio as Gerald Marcuse.

SWL REPORTS

Transmitters who would like listener reports are invited to send us details covering the band(s) and type of transmission on which they are required, the distances over which they are wanted, the QTH for QSL's and, if possible, the operating periods.

These details will be listed under "Pse QSL" in our *Short Wave Listener*, on the understanding that reports so received will be acknowledged by QSL card.

It is of interest to add that this feature is gaining rapidly in popularity, and "Pse QSL" in the March/April issue of the *Short Wave Listener* carries nearly a page of such insertions, more than half of which are from overseas. Further G requests received as a result of this notice will be held till the issue dated June, to be published on May 15.

READERS' HALF-GUINEA IDEAS

We shall be glad to see more of these; some of those coming in lately have been very good. But please do diagrams on separate sheets of paper, not run in with

Letter Budget

This will henceforth be a feature of F.O.C. activities and will carry all the Club news; matters of general interest, and election notices, will continue to appear in the *Magazine* each month.

Circular Letters

The honorary secretary will maintain the Circular Letters to members. These will be in the nature of HQ notices to keep the membership in touch with activities and to ask for opinions on current proposals.

Contest

It has been decided that the Contest to be held in the autumn will be open to all comers, with prizes for the leading F.O.C. member, the top-scoring transmitting non-member, and the winning SWL.

Transmitters interested in the F.O.C. and its ideals and standards are asked to get in touch with Capt. A. M. H. Fergus, G2ZC, 89 West Street, Farnham, Surrey (Tel: Farnham 6067) to whom all correspondence on F.O.C. matters should be addressed.

the text. The reason is, of course, that several different people are concerned with the preparation of the material before it finally appears in print, and they cannot all have one piece of paper at the same time.

For those who may not be acquainted with "Half-Guinea Ideas," see the December and February issues. All we want is an explanation in your own words, with clear diagram or photograph. We write the article—you get 10s. 6d.

WORD OF THANKS

Despite the serious dislocation in periodical printing due to the power restrictions, which in effect put the trade a good fortnight behind with production, the March issue was hardly more than a week late. We have much for which to thank our printers.

FIVE METRES

By A. J. DEVON

*The Aurora Opening
'Worked All Counties'
World's 50 mc Record
Summer Prospects*

IT does not seem very long since the last piece was being prepared for this space, but even in that short interval several interesting things have happened.

On March 8 there was an Aurora Opening, which amounts to the appearance, electrically speaking, of a very effective reflecting curtain in the Far North. The result was that during that evening many contacts were made and stations heard with beams looking North-West, instead of on the true bearing.

For instance, G5MA (Ashtead) with his beam on Liverpool, heard G5BD (Mablethorpe) working G5MQ. Likewise, G2XC (Portsmouth) received G5BY, also with the beam North-West, or about 90° off the line G2XC-G5BY. G5US (Camberley) had a similar experience, actually working G5BY with the beams of both stations aimed north.

G5BY was there as usual to take advantage of conditions, and his log of stations worked and heard during this Aurora period appears in Calls Heard. With him, the band was open from 1745 till 2015, and more signals were logged at one time than ever before. G6LK (Cranleigh) was arriving in S. Devon both direct and *via* Aurora, sounding like a W7 the third time round!

All operators who chanced to be on when this most interesting and unusual condition occurred report that the band was "noisy from the North." The outstanding characteristic of the phenomenon was, however, the fact that all signals went "fuzzy"—the usual T9 notes came down to a rusty T5 or even T3. This is due to phase distortion and multi-path interference, caused mainly by a high degree of scatter.

On the following Saturday, March 15, another Aurora opening was vouchsafed us, but of much shorter duration. But it enabled G5BY to work G6TT (Liverpool), reports exchanged being RST557-RST555; Hilton also heard G2IQ (Sheffield) at 334 while listening on G6TT.

The interesting thing about all this is that had more stations been on and realised that the right direction for the

beam was the wrong one, a new GDX record—say GM3OL with G2XC, G5MA or G5BY—would have been a reasonable probability. In other words, when this peculiar condition is evident, as shown by pronounced noise in a particular direction and dirty notes, aim the beam in that direction and keep calling and listening.

General Reports

G6VX (Hayes, Kent) has heard G5GX (Hull), whose partner up there, G6OS, has been received by G8SM (Molesey, Surrey)—so the Hull Twins are getting out all right and will certainly start knocking off the GDX when conditions serve.

G2MV (Coulsdon, Surrey) has heard G5ZT (Plymouth) and on March 9, G6FO (Penn, Bucks) received G8UZ (Sutton, Notts.) and G5MQ for a few minutes.

G5MR (Felpham, Bognor) has made a good start (see Calls Heard), having logged G5BD, though his best DX for a two-way as at March 8 was G6FO (60 miles). G5MR is using a long-wire aerial for the moment. He suggests that we reinstitute the "Test Periods" so as to encourage activity at given times. These were started in March of last year, but dropped in July, as by that time the band was becoming fairly well populated and with the sudden sporadic-E openings we were getting (which always happened at the wrong time for a Test Period), they lost their practical value. The same seems to us still to apply, except that there is still insufficient activity in the late afternoon and early evening, when conditions are often right for semi-GDX working.

But if people think Test Periods would be helpful again, particularly at these times, we shall of course be very glad to lay them on. Please give an opinion next time you write to the column.

From G2TK (Scarborough) comes a first report. He and G8SI of the same town (yet another pair of twins!) are on; G2TK hears G5BD regularly off the back of the latter's beam and has worked G6OS. G2TK/G8SI want schedules with the South and West, and also ask for co-operation from the Leeds, Sheffield and

NEWS FLASH

At 1330, on March 26, PAØUN was received on 50 mc by ZS1AX, ZS1P and ZS1T, at up to S9.

Nottingham areas. G2TK has a 3-element beam and an S27, and with G8SI, is there from 2100 each evening.

G5LQ (Chiswick, London), who has been active on five since November, from a difficult location has had 146 contacts with 50 different stations, though the real DX still eludes him—G2XC is the best to date. G5LQ now has a 3-element rotary in the roof space, with a 3-stage converter (EF50, EF50 mixer, 6J5 osc.) into the *Magazine* "All EF50 TRF Receiver" described some months ago by G5UM. Car noise is the trouble with G5LQ, and he is now grappling with the noise-limiter problem.

On March 13, conditions were fairly good, and G5MA worked G5BD—they keep regular watch for one another. G8WV (Hanslope, N. Bucks.) puts a very good signal down to the South, also with an indoor beam. As he can work the Midlands with comparative ease (he is actually near Northampton) G8WV is the liaison link between the London area and the Midlands.

G5BY is now running a schedule with ZS1AX, and though the MUF has recently been up to 45-49 mc on the G-ZS path, they have had no luck yet. He has a new 8-wave per leg rhombic which, in the preferred direction, is giving considerable gain over the 4-element beam. The line-of-shoot of the rhombic is on Europe for the sporadic-E openings we can expect a little later on. A new station heard by G5BY is G3AAK (Broad Hinton, Wilts) who has been well received several times, and called but without success.

Stations to be reported active are G3HW and G8FA (Teignmouth) and G3ATF of Bexleyheath, Kent, who is getting out well in the Home Counties area.

Arising from last month's notes, there are one or two small corrections to make: In Table 1 of the Contest Analysis, G5BY's Zone B total should be shown under Zone C, as he made no score in B; this does not alter scoring or placings in any way. His aerial ought to have been given as a 4-element and not 8-element. The call sign of the station mentioned on p. 41 as being "spot on 60 mc" should have been F8AV (as implied by the context) and G2YL corrects us (again!) on the matter of her QRP feat by explaining that her final is a doubler and not a straight amplifier, the preceding stage being a 14-28 mc doubler.

In the Fashion

During the last couple of months, we have been thinking over the possibility of establishing some sort of DX yardstick for

58 mc. Contests and the GDX working reported in this column satisfy the requirement to some extent, but are not sufficiently positive in the sense of setting an objective at which to aim.

WORKED ALL COUNTIES LIST

If you have worked 14 or more Counties on 58 mc, send a claim to A. J. D. for listing in "Five Metres." Claims should give one station and its location for each county claimed. Documentary proof is not required.

With modesty and trepidation, we therefore unfold the plan for the *Short Wave Magazine* 58 mc "Worked All Counties" scheme. We do not claim any particular originality for the idea—there is a good deal of this sort of thing going on just now, and what finally triggered us off was the "Worked All Zones" system of measuring DX achievement, introduced in his column in this issue by colleague L. H. T.

Anyway, here it is. There are 41 counties in England, 12 in Wales, 30 in Scotland, 6 in Northern Ireland, and 26 in Eire. For the moment, let us consider England. The total of 41 excludes the Isle of Man and the Channel Islands, ignores the fact that the two Ridings of Yorkshire, North and South Devon and East and West Sussex are separately administered (they therefore count as one each), remembers the County of London, and includes Monmouthshire in England.

Now, we don't want any argy-bargy about this—not to start with, anyway! The possible for England is 41, and like Walter Winchell's famous remark before Pearl Harbour ("I'm neutral, I don't care who kills Hitler"), we don't care who signs GW in that for our purpose Monmouthshire is going to be in England.

From *Magazine* records, 58 mc activity has been reported in 30 out of the 41 English counties. A careful study of the map suggests that from almost any part of England, on the basis of the best results so far reported by any 5-metre operator, 16 counties are workable. So let us begin by asking for claims from those who have worked *fourteen* or more counties. Starting from this datum point, a 58 mc WAC listing will be built up and printed periodically in this column.

Please send in your claim as requested in the panel appearing here. If the 14-worked level is too high, it can be reduced to 10 or 12—so long as we start somewhere,

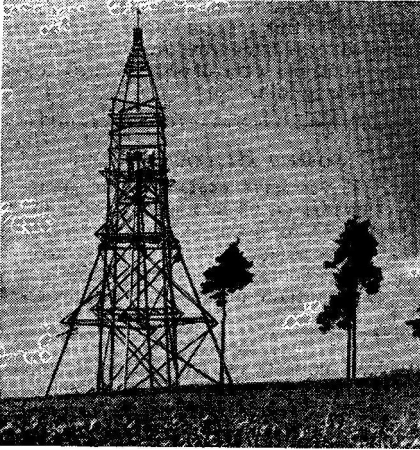

Site used by OK1AWX when operating portable. It is 700-ft. a.s.l. and not far from his home QTH.

it matters little, as the thing can go on indefinitely.

We have insufficient information to discuss the GM, GI and EI ratings, but would like to hear from anyone operating in those areas as to the degree of activity and the distances being worked. Of course, the whole scheme is interchangeable over all the G and EI areas. If a G works a GM, or a GW an EI or GI, the county in which the other station is located can be brought into the total.

Effectively, therefore, on this basis the possible becomes 115, but this is not likely to be achieved for a very long time, if only for the reason that (apart from other considerations) there is no known activity in a large number of these districts. We have only taken England as the example because the great bulk of the 5-metre activity is in the 30 G counties.

The eleven English counties in which, so far as our knowledge goes (and we don't pretend to know everything that everybody is doing), there is no 58 mc operation are Westmorland, Derby, Rutland, Huntingdon, Northampton, Bedford, Hereford, Monmouth, Dorset, Somerset and Cornwall. If anyone is doing anything on five in these districts—we mean, actually on the air fairly regularly with transmitter and receiver—will they please speak up?

The three Welsh counties in which there is known to be activity are Caernarvon, Denbigh and Flint. This makes a total of 33 possibles south of the Border.

Well, there it is. A simple and straightforward DX yardstick, with a placing

within the reach of all operators who spend any time on the band and are properly equipped for it.

Technical Item

As 14 mc crystals are now being made available by Messrs Standard Telephones & Cables, Ltd., it will be easier to get a transmitter going on 58 mc, G6VA (Warringham) has been using one recently.

European Note

OK1AA and OK1MC are working 'phone on 112 and 224 mc, over a distance 12 miles, high QRK's being obtained. OK2MV continues to put out automatic transmissions on 56 mc. F3CA (Plessis-Robinson) and F4AY (Moret-sur-Loing) have been in contact on five metres over 42 miles—this seems to be FDX record to date. (Acknowledgment *Journal des 8*).

The Pacific Contacts

WØZJB, in his VHF column in *CQ* for April, gives the distance for the J9AAK-KH6DD and J9AAK-W7ACS/KH6 contacts on January 26 last as 4,597 miles, calculated on the great circle path. This is the world's record for 50 mc.

With the coming summer, great things are anticipated in the States in the way of sporadic-E DX over the period April to October. Ducting is expected also to improve things on 144 mc, in which there is enormous interest among the W's; W8UKS has worked 110 stations on 2 metres!

European Possibilities

Similar propagation conditions should materialise for Europe, and any time from now on DX in the shape of southerly F's, HB's, I's and OK's should be breaking through. With the greatly increased European activity, and the more knowledgeable use of the band by many of the Continental stations, some very interesting DX sessions are in prospect.

Ducting and temperature inversion effects should also give better GDX and these conditions can be expected to appear with the first spell of warm weather.

And just to add to the excitement, we propose to run another Contest in July—details in the next issue.

Next Issue

Owing to the overlap, this has been a thin month for reports, So we look forward to a good crop for the May issue, closing date for which is April 22—or earlier. And so, till May. . . .

All 5-metre material should be addressed to A. J. Devon, c/o *The Short Wave Magazine*, 49 Victoria Street, London, S.W.1. (ABBEy 2384).

A 5-10 Converter for the R.1155

Design Incorporating a G.G.T. RF Stage

By G. ELLIOTT, B.Sc., A.R.I.C.

THE unit to be described was designed to meet the need for a fairly simple but efficient converter, which could be made up quickly to enable 5 and 10-metre reception to be had in conjunction with the R.1155 communication receiver.

No claims of particular originality are made for the circuit. It was decided to employ a grounded grid RF stage to give good amplification, with the best possible signal-to-noise ratio, this being particularly useful on 5 metres. The grounded-grid triode circuit is based on the articles on Grounded-Grid Technique appearing in the November and December, 1946, issues of the *Short Wave Magazine*, to which readers are referred for fuller information. The oscillator section of the frequency changer is a standard circuit usually recommended for efficient operation on 10 metres and below.

Referring to the circuit diagram (Fig. 1) the input from a dipole aerial is fed into the cathode circuit of the grounded grid triode *via* an 80-ohm feeder. The feeder can consist of concentric cable (e.g. the polythene dielectric type, of which large quantities are available) or parallel twin-wire (e.g. the Belling-Lee product). In the case of the concentric cable, the outer braid is connected to earth. Twisted flex is *not* recommended, as it is often a poor match and has very high losses in wet weather—this applies particularly to 5 metres.

The RF Stage

The input tuning circuit L1/C2 has a band-width of about 100 mc and so only requires pre-set tuning for the entire frequency range covered by the converter. L1 is about 0.2 μ H, or 4

turns of $\frac{1}{8}$ -in. diameter in 16 or 14 SWG copper wire. The coil is self-supporting and is wired directly on to the cathode pin of the valve-holder, the other end being connected to a midget stand-off insulator. C2, which is a ceramic air-trimmer of 60 μ F maximum capacity, is also wired directly to the cathode pin, but is so positioned as to be easily accessible for adjustment purposes.

With regard to the grounded-grid valve itself, the most suitable type is the CV66 (RL37), but a VR137 (RL16) was available and was successfully employed in the circuit described. The bias resistor R1 is 150 ohms for the CV66, but in the case of the VR137 the best value appears to be about 300 ohms. The low resistance chokes RFC2 and 3 are necessary to maintain the input capacity at the correct value and are home constructed, consisting of about 60 turns of 24 SWG enamelled copper wire, split into three sections, single layer wound on a glass tube of about 0.2-in. diameter. These chokes are connected as close to the heater pins as possible.

In the series-tuned anode circuit L2/C3, L2 has a value of 0.8 μ H for 5-metre operation, given by a self-supporting coil of 16 or 14 SWG enamelled copper wire of 8 turns, $\frac{1}{8}$ -in. diameter, spaced the diameter of the wire. For 10-metre operation, an inductance of about 3.5 μ H is required, and for this purpose a standard short-wave coil former was used, giving a coil diameter of about 1 $\frac{1}{8}$ -ins. A section 1-in. long was sawn off the former and 8 turns of 22 SWG enamelled copper wire were wound on this. Two midget ceramic stand-off insulators are used for the coil mounting, being placed in a convenient position for coil changing.

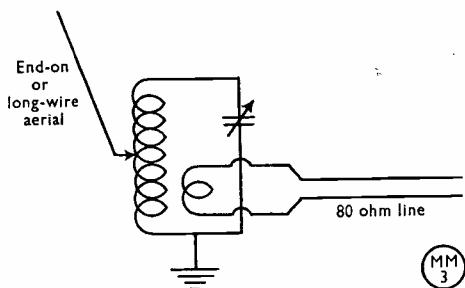

Fig. 2. Coupling the RF stage to an end-on or long wire aerial.

The coils are provided with tag-ends. C3 is a standard short-wave tuning condenser of $160 \mu\mu\text{F}$ and is used to vary the inductance of L2. The wave-band covered is much narrower than with parallel tuning and a different coil is required for nearly every wave-band. The values for coils for wave-bands other than 5 or 10 metres can be found by experiment. The tuning of C3 is quite flat and no slow motion drive or dial is really necessary. In the converter as constructed, the control is simply a small knob at the side of the unit, which is rotated for maximum signal strength.

The valve-holder for the grounded-grid stage is a ceramic British Loctal. All earth connections in this stage are taken to the centre tag of the valve-holder, which engages with the locating key on the valve.

The Frequency Changer

The valve employed in the frequency changing section is an X66 triode-heptode. The mixer section of the valve has aperiodic input and output circuits, the input being across a 250,000 ohm resistor and the output across an all-wave type RF choke. The output choke used is the Eddy-stone 1066, which enables any intermediate frequency to be used as desired, and also gives a high output load with negligible voltage drop. The output circuit is decoupled by R7 and C13. If any trouble is experienced from stray RF currents it may be to advantage to insert a VHF choke in the

anode circuit at the point X, but this was not found necessary here.

The oscillator circuit can be relied upon to give strong oscillation over the entire frequency range and thus maintain good conversion conductance. The oscillator coil L3, of $0.4 \mu\text{H}$, consists of 5 turns of 16 or 14 S.W.G. enamelled copper wire, $\frac{3}{4}$ -in. diameter and is tapped at $2\frac{1}{2}$ turns. Together with the main tuning condenser C10, the entire frequency range is covered, and no coil changing is required. For this reason the coil may be soldered directly on to the terminals of the variable capacity. This condenser should preferably be SLF and not the semi-circular type, in order to give even frequency calibration of the dial. The band-spread condenser C11, although not used in the original unit, is to be recommended for spreading out the stations in the crowded amateur bands. In the original unit, a 4-in. dial with 100 : 1 ratio drive was connected with C10, and a similar dial is recommended for C11.

Note that the fixed and moving vanes of the tuning condensers are at RF potential and also carry HT. In the unit described, the tuning capacity had a polystyrene end-plate, which was drilled to mount it on pillars projecting horizontally from the back of the panel carrying the dial. Coupling to the dial is made by a flexible coupler employing ceramic or other RF insulation.

The resistor R9 acts both as a decoupling agent, together with C12, and for voltage adjustment, to produce the optimum oscillation amplitude in the circuit. C8, connected to one side of the heater, will minimise hum modulation of the oscillator.

Coupling between the RF stage and the frequency changer is by a pre-set air trimmer C5. In the circuit described a certain amount of regeneration occurred in the RF stage and this was to some extent controlled by the adjustment of C5. It was possible to find an optimum setting of C5 which gave maximum signal strength by the correct proportion of regeneration and capacity coupling.

Some Constructional Points

The wiring must be as short and direct as possible, and all components carrying RF soldered directly to the valve-holder pins. The tuned circuit of the frequency changer should be mounted as close to the valve as space will allow. By giving careful thought to the layout a very compact unit can

be constructed. The unit as built had a chassis of aluminium sheet and only occupied a space about 6-ins. x 7-ins. x 6-ins. The RF and frequency changer sections were made as sub-assemblies, and almost completely wired up on small sheets of aluminium before being fixed into place on the main chassis. Care should be taken in the RF stage to avoid interaction

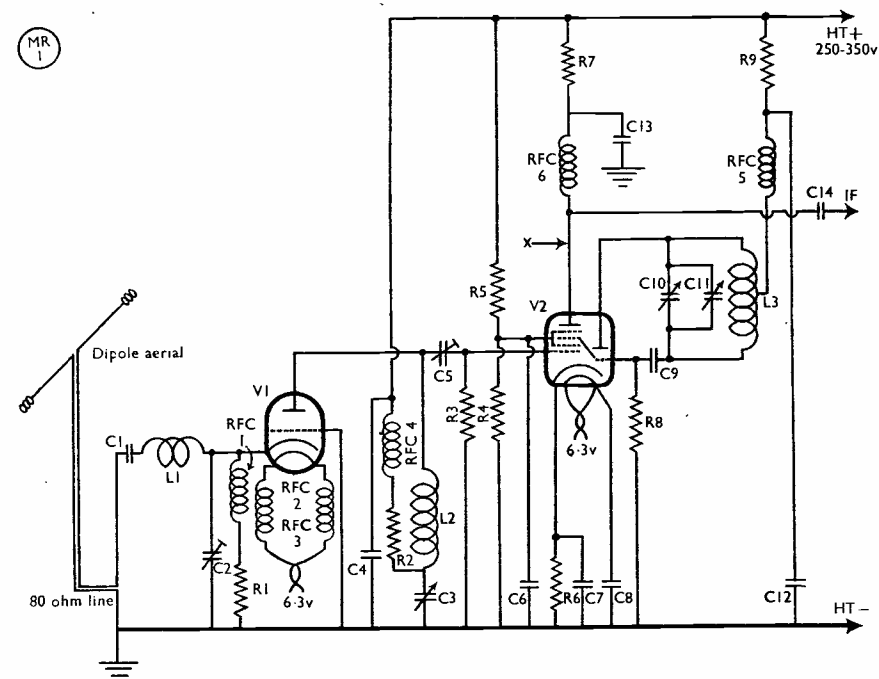

Fig. 1. A grounded-grid RF stage is used, coupled to an 80-ohm aerial feeder. An alternative method of aerial coupling is shown in Fig. 2.

Table of Values

A 5-10 Converter for the R.1155

- C1, C4 = .0003 μ F mica
- C2, C5 = 60 μ μ F air-trimmer
- C3 = 160 μ μ F
- C6, C7, C8 = .01 μ F mica
- C9, C10 = 100 μ μ F
- C11 = 15 μ μ F
- C12 = .0003 μ F mica
- C13 = 0.1 μ F tubular
- C14 = .0003 μ F tubular
- R1 = 150-300 ohms (see text)
- R2 = 5,000 ohms
- R3 = 250,000 ohms

- R4 = 30,000 ohms
- R5 = 25,000 ohms
- R6 = 250 ohms
- R7 = 7,000 ohms
- R8, R9 = 50,000 ohms
- L1 = 0.2 μ H
- L2 = 0.8 μ H (5 metres),
3.5 μ H (10 metres)
- L3 = 0.4 μ H
- RFC1, 4, 5 = VHF RF chokes
- RFC2, 3 = Low-resistance VHF RF chokes
- RFC6 = All-wave RF choke
- V1 = CV66, or VR137
(Mullard RL37 or RL16)
- V2 = X66

between the input and output circuits by wiring these above and below the aluminium sheet.

When the power supply is the same as that used for the R1155, a double-pole switch should be provided for cutting out the HT and heater supplies when listening on the R1155 alone. The drawing (Fig. 2) gives a general idea of the author's design, the RF stage being on the upper part of the chassis.

Operation

With the tuning capacity specified the frequency band covered will be about 23-68 mc, with the oscillator working on a higher frequency than the received signal and using an intermediate frequency of about 1.5 mc. A voltage supply of 6.3 volts is required for the heaters and 250 to 350 volts for the HT, both of which can be taken from the power-pack supplying the R1155. The higher voltage was used, but if only 250 volts are available, the bias resistor R1 could be reduced to 150 or 200 ohms and R9 reduced to 30,000 ohms. On a 350 volts supply the frequency changer is actually working on voltages higher than those specified by the makers, but this gives good output and does not appear to have any undesirable effects—with the circuit values given, the current consumption of the valve is only a little higher than the specified value.

Connection between the R1155 and the output terminal of the converter should be made by means of a short piece of screened lead. The R1155 uses for an aerial terminal a small stand-off insulator fixed to the side of the metal cabinet, and in this manner the connection can be made very short.

A suitable dipole aerial system is connected to the input terminals of the converter. The adjustment of the input circuit is not at all critical and C2 will probably need to be set near its minimum position. The best setting was found by using a signal generator and an S-meter connected to the R1155, but it could be obtained by using a local signal on 5 or 10 metres and

tuning by ear, although this is not so satisfactory.

The optimum setting of C5 should now be found (this has some control over regeneration, as previously mentioned) and once again this can be performed by ear, although a signal generator is preferable. This adjustment should be conducted on 5 metres, as it is much less critical on 10 metres.

In the absence of a signal, the anode tuning by C3 is easily adjusted by listening for maximum circuit hiss. Tuning with the main tuning condenser C10 on the slow motion dial is very sharp but quite stable, and no hand capacity effects were observed on the author's model. If the R1155 is operated in the usual manner with the earth connection to the chassis, but not to the HT negative line, then the earth connection to the converter should be made *via* a mica 0.001 $\mu\mu\text{F}$ condenser, to avoid short circuiting the RF volume control.

Still using the same oscillator coil, it is possible to receive signals on the 47-137 mc band by making use of the second harmonic of the oscillator. A suitable value for L2 has to be found, of course, for the frequency it is desired to receive. The efficiency of the converter is not quite so high, but it has been operated successfully on 80 mc, for example, using a 5-turn $\frac{3}{4}$ -in. diameter coil for L2.

Aerial Coupling

The input circuit is not suitable for any aerial except a dipole with 80-ohm feeders, but if it is desired to employ the inverted-L type, for covering a large range of frequencies, or the long wire resonant type, then an aerial matching system must be used. This can consist of a parallel tuned circuit with the aerial tapped on to the coil and a single turn coupling link, feeding an 80-ohm link to the converter unit, as shown in Fig. 3.

A large number of interesting transmissions can be found at various times on the frequencies covered by this converter. Starting at the low frequency end, there is world-wide DX on the 27 and 28 mc amateur bands,

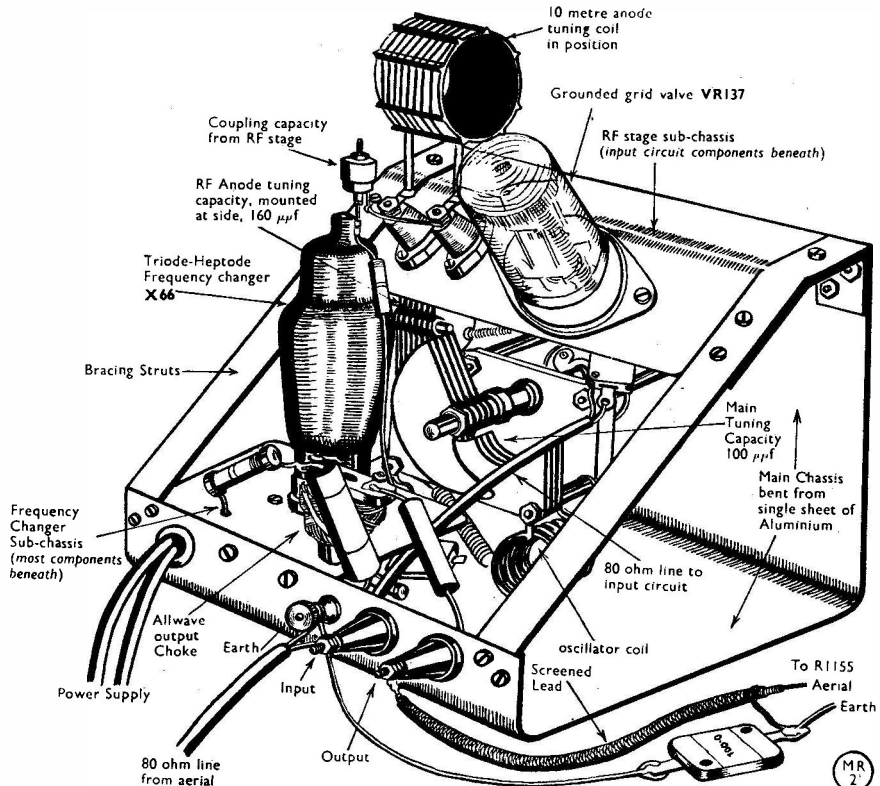
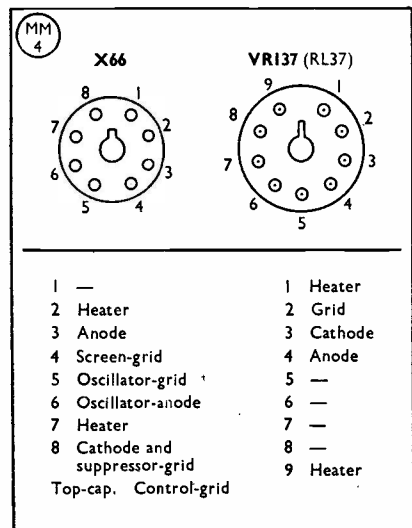

Fig. 3. Sketch showing the physical layout, using a chassis adapted for the purpose and shaped from a single sheet of aluminium. The parts visible can be related to the constructional data in the text and the circuit diagram.

meteorological sounding balloons between 27 and 28 mc, U.S.A. police and experimental broadcast transmissions above 30 mc, together with television transmissions and American amateurs on the 50 mc band (some have already been heard in this country); on the British 58 mc amateur band, there is considerable activity just now, with much interesting work to be done, together with occasional European DX produced by sporadic-E; and finally, local communications on frequencies above 60 mc.

On the bands from 60 mc upward it is quite permissible to use higher intermediate frequencies, and instead of tuning the R1155 to about 1.5 mc as before, adjustment to, say, 7.5 mc will give quite satisfactory results.

Fig. 4. Connection diagrams for the X66 and RL37 (CV66 or VRI37) types, looking at the base of the valve.



OFF THE AIR

By THE OLD TIMER

Playing Safe
Transformer Failures
T9x VFO on 28 mc?
Points about Links

THE title of this article, which will in future be a not-too-regular feature, is inspired by the fact that every amateur spends (or *ought* to spend) a good deal of time on the gear without being on the air. Of course, we all know that there are many whose very first action after switching on the light, the receiver and the transmitter is to reach for the microphone and call CQ—but a good many of that type can't read, and therefore will not be interested in this.

The average keen sensible amateur probably spends *more* time around the shack pottering, cleaning up, modifying and just tinkering than he actually does on the air; and while he undergoes innumerable lectures and homilies about what he should do when he is on the air, he doesn't receive much guidance about such things as invariably go wrong *off* the air.

These articles, therefore, will deal with happenings in my own shack—from the ruining of a pullover by a squirt of hot solder to the discovery that twin flex is not so hot for link coupling. They are written by one dabbling amateur for another, in the hope that one or two of my own mistakes and discoveries may help someone else in a similar struggle.

For this very reason they may be a little disjointed, leaping from subject to subject (and from crisis to crisis) in the manner of one of those beautifully unstable oscillators we have all met!

Danger de Mort

The first thing that strikes me is that amateurs must be pretty tough in the volt-proof sense, or few of them would remain alive. The absence of safety precautions in the average amateur station is quite frightening. However haywire the rig may be, however flexible or temporary the arrangement of the units, there is no sense in risking a sudden and permanent QRT for the want of an extra switch, or relay, or pilot lamp. In this connection I should like to say that the justly popular system of grid-block keying is potentially lethal. Take your hand off the key and the CO or VFO stops oscillating and every-

thing is strictly dead from the RF point of view—all the meters at zero and everything silent—but those piled-up DC volts are just sitting there waiting to reach out for the odd finger or wrist brushing past.

For myself, I do all switching by GPO relays, and the whole bunch of them are controlled by a GPO switch adjacent to the key. It has become such a matter of habit to flick this switch to "off" before moving out of my chair that if I want to tune the final tank with the power on I generally have to go back to the receiving position because that switch *was* knocked off. One of the relays breaks the primary of the HT transformer, and the main filter condensers have 2-watt $\frac{1}{2}$ -megohm bleeders across them. The spare contacts on this same relay light a pilot lamp (12-volt bulb on a 6-volt circuit!) on the chassis of the final.

Of course, one still has to play with controls with the volts on, but then one's instinct of self-preservation keeps one's hands away from the hot spots.

Another point is that parallel feed for the final tank is much more healthy than series feed. My own tank coil has a centre-tap which goes straight down to earth. The 1,000-volt positive lead to the anode and one side of its coupling condenser are well toward the back of the chassis and rather inaccessible. When using series feed I found it far too easy to "catch a packet" through carelessness.

As this did not set out to be a treatise on safety precautions, I need say no more; but for goodness' sake, *watch it!* If almost any amateur of my acquaintance were to burn himself out in the shack, I am convinced that no insurance company, after inspection of the wiring and the "precautions," would pay up. (And there won't be anyone to clean up that wiring *after you've gone.*)

Screen Grids

Another point about grid-block keying is the dangerous way in which screen volts can soar when your final has its screen fed through a dropping resistance. In my own case I run the PA at 1,000 volts on the

anode and 400 on the screen. With the original arrangement of a heavy-duty dropper only, naturally the screen went straight up to 1,000 when the drive went off. This did not damage the valve but gave rise to a tendency for it to make strange squegging noises, even though the stage was biased to about twice cut-off.

Now, if you use plate-and-screen modulation you will not want to derive your screen voltage from a potential divider, or you will have to re-hash all your modulation circuits. So the solution, in my own case, was the provision of a fairly *high* resistance from screen to earth. This does not hold the screen volts down to normal when the key is up, but passes enough current to stop the squegging effect and, incidentally, provides yet another bleeder across the HT supply. The actual resistor is of about 80,000 ohms, and the current passing through it shows on the screen-current meter in addition to the actual screen current. Thus, with the drive off, there is a reading on the meter which serves as a dual indication that there are still volts about.

Transformers

It is not surprising, considering the age of some of my mains transformers, that I have had a couple of burn-outs during the last two or three weeks. What *is* surprising, though, is the material of which the terminal panels of some of them are made. A little 300-volt power pack went "poof" the other day and ejected a ball of black-smoke, like a miniature atomic explosion. Naturally I switched off in a hurry. Now that should have been the end of it, but no! I had to go on hands and knees into an inaccessible corner, blowing like fury at the top of the transformer, which was burning like a celluloid collar! Just reflect that fuses are no precaution whatever against *this* sort of fire; and if it were to take place among wooden panels and baseboards, you might have to wreck quite a lot of gear putting it out. My other transformers have been duly examined and several of them modified.

VFO's

If you want to set yourself an absorbing task that will stir your wits and keep you busy for quite a while, do as I did and set out to make a VFO which will give you T9x reports, and nothing less, on 28 mc. Most good VFO's will fetch in T9 (or sometimes T8x) but that honest T9x requires some perseverance.

In my own case the chief trouble was that the 150-watt PA put a little RF back

into the mains wiring, but only on 28 mc. This RF, strangely enough, does not have the slightest effect on the frequency of the VFO (in other words there is no chirp whatever) but it does tend to introduce some hum which is not there under "key-up" conditions.

Eventually the oracle was worked by using link coupling practically all the way through. It seems to be those high-potential leads from one anode to the next grid that pick up all the dirt (and quite logically so). Keep your tuned circuits physically small, close to the associated valve but well spaced from the next one, and link-couple them, and you will really have a variable frequency "crystal."

Incidentally I rather like the dodge of coming out of the VFO on a short length of concentric soldered right into a standard crystal holder. Just take out the crystal you are using and plug the VFO output into the socket, and you can use the same form of keying, the same settings of controls and you will not have to modify your CO/FD unit in any way. (You will of course, have to put in a blocking condenser somewhere at the other end of the concentric so that plugging in the VFO/crystal-holder does not short out grid leaks and things.)

Links and all That

Talking of link-coupling, it is surprising how some people go to great lengths to provide high-Q circuits and then couple them into an appalling link which delivers less than half the power at the far end. Twisted lighting flex is about the world's worst; the PVC stuff, however, is much better than the rubber-covered. Short lengths of concentric are better still. If you want 8 mA of drive and can only get 5 mils, just scrap that dirty old link and try something better; you will probably be surprised and pleased at the result.

And as for crocodile clips. . . I know, I still use them myself, but judging by the temperature of my aerial clip on occasions, it's time I stopped. Fancy going to great trouble and expense to generate *RF energy* for the purpose of heating a little bit of iron. And, as G5UM said last month, coil terminations leave a lot to be desired. The "screw-down-hard-under-wing-nuts" type are the most efficient but the slowest. The "banana-plug" type are probably the least efficient but the quickest. Personally, I am all against coil changing in any form, but what is one to do? We haven't all got room for a row of 150-watt PA's, but if you swallow your pride and use just under

100, with a pair of 807's, such PA's can be made delightfully small.

A point worth thinking of is to make them on longish, narrow breadboards, with the valves mounted horizontally, and then to mount the assemblies vertically or even hang them on the wall! They take up no room that way, and each band can be given its permanent tuned circuit with the right L/C ratio and the most robust of connections. All that is wanted for band-changing then is a wandering link and a three- or four-position switch to supply modulated HT to each PA in turn. Think it over—it's only just occurred to me, but it sounds good.

CORRESPONDENCE

Readers may wonder why "Some Letters to the Editor" does not appear more frequently—always an interesting feature in any periodical. The reason is not lack of material, but considerations of space. Nevertheless, we hope the Correspondence column will make a regular appearance in future. While all correspondents should assume that their letters are liable to be published (unless they specifically ask otherwise), we usually inform the writers concerned if it is intended to print their letters.

We must apologise for some delay recently in dealing with letters in the Editorial department. We welcome a large mail—but please do not expect an immediate reply, as there are certain periods in the month when the editorial staff is very busy with the preparation of material for press. This produces an accumulation, and hence the delay.

THE CALL BOOK

The Winter 1946-47 edition is of 280 pages. Some statistics: There are over 70,000 W's listed, but only a bare 2,000 G's. Those given in our "New QTH's" up to the September issue are included—so the Call Book is still a long way behind, and the G listings are obviously very incomplete. There are more PY's (27 columns) shown than G's (22 columns). Canadians total about 2,500, but no VK's at all appear since the Australian authorities have ruled that amateur QTH's are copyright and therefore must not be published!! The Americans of course far outnumber the whole of the rest of the world put together.

Operating Position

Do you sit comfortably at your receiver with the main transmitter controls within easy reach? Or is your receiver mixed up with a whole pile of VFO's, drive units, speech amplifiers and the like? This business of a comfortable operating position is important. After all, it's where you sit when the station is in use, and you look after your personal comfort in the other rooms in the house—why not in the shack? Get the receiver at the right height; mount the key, if necessary, on a shelf below bench level; have your switches easily to hand; give yourself some light on the log with an Anglepoise or some similar type of lamp. You will never regret trouble expended in this way. And it looks good, too.

M.O.S. CATALOGUE

Their No. 3 issue is a useful list of all those items always wanted by the constructor, and covers a wide range of equipment at highly competitive prices. An interesting introduction is the Burgoyne Co-Axial Connector, which is designed to ensure a good weatherproof connection to low-impedance fed aerials. Messrs. Mail Order Supply Co., 24 New Road, London, E.1.

G.E.C. TYPE 2 CRYSTAL UNITS

The new prices of the G.E.C.-Salford Type 2 Quartz Crystal Units, reviewed on p. 441 of the September issue of the *Magazine*, are now as follows:

3.5-3.75 mc and 7.0-7.5 mc

Random frequency in either range, 35s. each,

Specified frequency ± 10 kc, 42s. each, S.E.I. Type Q.C. 110 Crystal Socket, 2s. 3d.

Messrs. Salford Electrical Instruments, Ltd., Peel Works, Silk Street, Salford, Lancs.

"MONTH WITH THE CLUBS"

As explained in the March issue, Club news is being held over for this month, as there has not been time for the full quota of reports to come in. Would secretaries please let us have their reports for the May issue, addressed Club Secretary, 49 Victoria Street, London, S.W.1, by April 16 latest.

Adding Mains Voltage

Simple Boost Transformer

By J. OSTLE (G2DYV)

In these days of mains overloading it is becoming increasingly difficult to get any reasonable output into the aerial during the hours of daylight, due, in the writer's case, to some 28 volts drop in the mains supply. Since a 30-volt drop in the primary means anything up to half-a-volt drop on filaments, output may be reduced by as much as 25 per cent.

After a week or so of this trouble it was decided to build a boost transformer and results have been so satisfactory that the details are offered here for those who may suffer from the same trouble and may like to try a very simple remedy.

Transformer Modification

The equipment consists of an old mains transformer with the primary intact and a 5- or 6-pole rotary switch. AW 0-300 AC voltmeter is desirable for checking the line and/or output voltages, but not essential if a test-meter is available when required. The secondary of the transformer is wound with enamelled or DCC copper wire of No. 20 gauge, to give some 20 to 30 volts. This secondary, which can be wound over the existing burnt-out one, is tapped every 5 volts, the idea being to put this extra voltage in additive phase with the mains when it is required to bring the line voltage up to its nominal value. The switching arrangement will be self-explanatory by reference to Fig. 1.

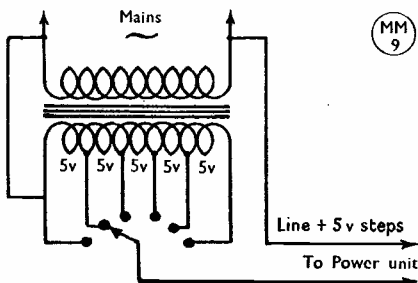

Fig. 1. Circuit of G2DYV'S arrangement. The boosting secondary can be a sufficient number of turns rough wound to give a total of 30 volts. The switch taps the required additional voltage to boost the mains.

If it is desired to vary the voltage in similar steps either way, another switch bank and a centre tapped transformer will be needed as in Fig. 2.

The number of turns required can be obtained by experiment or by counting the turns on existing filament windings; the winding necessary to produce 30 volts can then be roughly calculated and the voltages taken off in 5-volt taps.

Precautions

A point to watch is that the secondary winding must be connected in phase with the primary for boosting the output

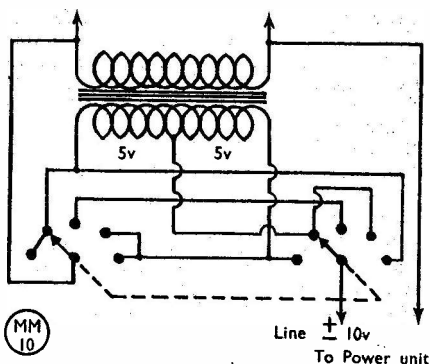

Fig. 2. The same idea adapted to give a plus or minus variation of line voltage.

voltage; this can easily be found by experiment—the wrong way round will give less voltage.

All that is required to bring the mains voltage to its nominal value is to adjust the switch with a meter across the output. It should be pointed out, however, that in order to switch from one step to the next without a break in the supply, it is best to employ the type of switch which maintains connection with one contact until after the next is made. It is also advisable to insulate the spindle mounting from earth to avoid any tendency to flash-over. And use an insulated knob on the switch!

Here and There

International Telecommunications Union

A second "preliminary clearing of the ground," by a select committee of the Great Powers, took place in Paris at the end of February, the subject again being frequency allocations.

As mentioned in our last issue, the I.T.U. meeting will be held in Atlantic City; the date for the opening session has since been announced as May 15. It will probably not be till the middle of the year that any firm statement can be expected as to the amateur bands.

Crystal Exchange

If you have an unwanted crystal to exchange, read the notice on p. 759 of the February issue. The first offerings appeared last month. Insertions in this section are free, but can be accepted on an exchange basis only. Please set out your request in the manner shown on p. 35 of the March issue. As this goes to press before that issue is fully distributed, all insertions received will be held over till May.

Anything for You?

The *Short Wave Magazine* QSL Bureau holds cards for the G's listed below, whose full addresses are not known to us. Send two or three stamped addressed envelopes of a suitable size to BCM/QSL, London, W.C.1, and these cards, with any that may arrive subsequently, will be forwarded.

G2ADL, G2DPZ, GM2TW, GM3AJZ, G3AP, G3AVD, G13IA, G3OT, G3VP, G4IB, G5DW, G5XT, G6FV, G6SP, G6SY, G6VY.

Safety Factor

If you have one or two little harmonics who like to come into the radio room to "watch Daddy's wireless" you will, being a sensible person, have adopted various precautions to prevent small fingers finding their way to the hot end of the power pack and similar dangerous places.

Should you have no harmonics of this particular variety and perhaps no concern for anyone's safety, including your own, you should still consider your visitors.

Earth everything that should be tied down to ground. Instal a kick-switch at the operating position that will knock power off the whole station if anything horrifying does begin to happen. Put safety guards on all HT equipment and place the permanent gear where it cannot be fiddled with; that is, out of too-easy reach.

"Planning the Amateur Bands"

As there is a move to obtain GPO approval for the principle of band partition, we have decided that it would be right to allow our own proposals—which have the unqualified support of the great majority of those who commented upon the article on this topic in our January issue—to stand over for the time being. We feel that on this subject a concerted policy is desirable from every point of view.

In the meantime, it is suggested that a step in the right direction would be for CW operators to use the LF ends of the DX communication bands.

ARRL DX Contest

Further to the note appearing on p.747 of the February issue, do not forget to let us have your final score for mention in "DX Commentary." The G results that we receive will appear in the May issue.

Magazine Services

The New QTH, Pse QSL (*Short Wave Listener*) and Crystal Exchange sections, as well as the news article columns in the *Magazine*, are open to all readers irrespective of whether they are direct subscribers. We mention this simply because a certain number of enquiries have been received on the point. The only reservation is in regard to the QSL Bureau; those who wish to use it both ways must be direct subscribers.

Corner Comment

And there is just room to thank the reader who has been kind enough to ask after G9BF. He is keeping too well and is busy as usual inventing something or other.



WHERE'S DEM RESCUERS !

A B C C

By THE OLD TIMER

Owing to the late appearance of last month's issue, it is not yet possible to assess the response to the idea of ABCC. Sufficient to say that it looks good from the cards received over a very short period.

Last month's preliminary announcement of the kind of rules to expect was rather a negative one; so now we may as well consider a few positive suggestions. Suppose every active amateur in Great Britain were a member of ABCC and adhered to what we have agreed upon in general principle. What would the bands be like?

Well, first we should hear the 'phones talking plain English of a kind that would convince the casual listener that they were intelligent, sensible people. Their conversation would not consist of handles, "K, someone, please," "Q S Baltimore" (what a way of saying "fading"!) and "OK about my sigs being OK over there."

Next, we should have a clear space at the LF end of each band for the CW operators, and the 'phones would be content with 80 per cent. of the bands instead of 100 per cent.

Then, when a rare DX station called

CQ, we should not hear a lot of blooming VFO's tuning up on him—one of the most depressing sounds ever heard since the air-raid sirens. And we likewise shouldn't hear a batch of hopefuls start calling him before he had finished his first QSO.

We shouldn't find six or seven G's calling "CQ DX" on the same frequency as a DX station calling CQ, because they would have listened first.

We should also miss the seven- and eight-way QSO parties which ought to break up after exchanging reports all round, but on finding nothing else to say, fetch in the YL's and XYL's and make the whole thing sound like any small-town coffee-shop at 11 a.m.

Now, do you think that would be nice, or would you miss all these things? It could be done. If enough readers support ABCC and pledge themselves to its aims, it may not be very long before some of the offenders begin to realise that they are out in the cold and not even getting all the QSO's that they might.

Just post us a QSL card marked "ABCC—In Favour."

NEW QTH's

Only those which have changed since the appearance of the September, 1939, issue of the Call Book or were not included in it for fully licensed operation, or are now licensed for the first time, can be published here. All that do appear in this column will automatically be included in the next Call Book, now in preparation. The number of QTH's we can print each month depends upon space available. QTH's are inserted as they are received, up to the limit of the space allowance. Please write clearly and address to QTH Section.

G2ACV	G. W. Satchwell, 187 Damson Drive, Elmdon Heath, Solihull, Warks.	G3BFV	Cdr. A. J. Marsh, R.N., R.N. Signal School, Fort Southwick, Nr. Farnham, Hants.
GM2AIK	G. M. B. Rankin, 15 Woodburn Terrace, Edinburgh, 10.	G3BGF	R. Winkworth, 181 Broadway, Didcot, Berks.
G2AKH	J. Williams, M.A., Ph.D., 52 Church Road, West Kirby, Cheshire. (Tel.: Hoylake 3952)	G3BHC	Capt. R. T. R. Cocks (ex-VS1BH), Perranuthnoc, Penzance, Cornwall.
GM2AKJ	C. L. Philips, 29 Camphill Avenue, Langside, Glasgow, S.1.	G3BJF	D. T. Carter, Gwenmore, Kent Road, Quinton, Birmingham, 32.
G2AKR	D. Barber, 14 Finchley Grove, Moston, Manchester, 10.	G3BJN	T. L. Johnson, 41 Scott Park Road, Burnley, Lancs.
G2AKV	A. Wilkinson, Ivy Cottage, Flawith, Ainc, Yorks. (Tel.: Tollerton 217.)	G3BJP	F. E. Lancaster, Hawthorn Bank, Bailey Hills Road, Bingley, Yorks. (Tel.: Bingley 475.)
G2BJK	G. F. Brown, Brantham, The Barrows, Cheddar, Som. (Tel.: Cheddar 105.)	G3BJW	B. R. Cullum, 34 Butter Hill, Wallington, Surrey.
GM2BNG	D. A. R. Speers, 6 Gavinburn Gardens, Old Kilpatrick, Dumbarton.	G3BKU	C. E. Bridgewater, 19 Bernard Avenue, Ealing, London, W.13.
G2BPF	P. F. Ballard, Whitehaven, Manor Road, Farnborough, Hants. (Tel.: Farnborough (Hants) 589.)	G3BKY	J. C. E. Taylor, 135 Lavenham Road, Southfields, London, S.W.18.
G2BUW	R. R. Butler, 278 Evelyn Court, Amhurst Road, Hackney, London, E.8.	GW3BLC	L. C. Hopkinson, Rose Leigh, Pentlepoir, Saundersfoot, Pems.
G2CIN	T. M. Lott, 47 Killieser Avenue Streatham Hill, London, S.W.2.	G3BLN	P. M. Trowbridge, Fordland, Church Street, Lymington, Hants. (Tel.: Lymington 638.)
G2NG	J. M. R. Sutton, B.Sc., 75 Langham Road, Teddington, Middx.	G3BLY	A. Thomson, 38 Station Road, Fowey, Cornwall.
G3ACJ	E. D. Watterson, 3 Hatherley Court Road, Cheltenham, Glos. (Tel.: Cheltenham 4443.)	G3BMF	Capt. C. J. Smith, 82 Framingham Road, Brooklands, Ches.
G3ACT	F. Owen, 111a Bishops Park, Bishops Cleeve, Nr. Cheltenham, Glos.	G3BMG	G. H. Simmonds, 36 Claude Road, Rye Lane, London, S.E.15.
G3ASC	E. D. Power, Albion Hill, Oswestry, Salop.	G3BNE	G. W. Alderman, 3 South End Close, Hampstead, London, N.W.3.
GM3AWW	W. S. Murray, Rockfort, Tannoch Drive, Milngavie, Glasgow.	G3BNI	D. L. Coppendale, 9 Morden Road, Chadwell Heath, Essex.
G3AXL	H. A. Ballard, 341 Old London Road, Ore, Hastings, Sussex.	G3BTR	T. J. A. Rose, 157 Battersea Park Road, London, S.W.8.
G3AXZ	S. E. Slade, 84 Great Portland Street, London, W.1.	G3CT	Major E. H. Cox, Dunstall Close, Burgess Hill, Sussex.
G3AYJ	D. W. Morris, 38 Mansfield Road, Aston, Birmingham, 6.	G4DA	J. H. Townshend (ex-G5TN), c/o Scopphony, Ltd., Wells, Som.
G3AYX	N. C. Nicholls, 20 Ennismore Avenue, Chiswick, London, W.4.	G5HB	H. Bittcliffe, 30 Wellington Square, Waichfield, Nr. Swindon, Wilts.
G3AZL	J. D. Stroud, 20 Green Court Avenue, Croydon, Surrey. (Tel.: Addiscombe 2360.)	G5XV	R. Y. Parry, Halcombe, Malmesbury, Wilts.
G3BBA	A. C. Stockley, Cross Roads, Towcester, Northants. (Tel.: Towcester 129.)	G6AW	W/Cdr. W. E. F. Jennings, O.B.E., Devonia, Bournemouth Drive, Herne Bay, Kent.
G3BDV	P. J. Cott, 29 Cleveland Park Avenue, Walthamstow, London, E.17.	G6WM	R. H. Roling, 18 Canadian Avenue, Gillingham, Kent.
GM3BEB	T. M. Bowden, 60 Crossgate, Cupar, Fife.	G6XX	D. E. Scarr, 25 Hailgate, Howden, Goole, Yorks.

SUBSCRIPTION RENEWALS — CHANGE OF ADDRESS

Renewal slips are going out with each month's issue as subscriptions fall due. It is only necessary to return the notice with your remittance.

And please inform us immediately of any change of address. The envelopes in which the issue is despatched are prepared in advance of publication date. Copies may go astray if changes of address are not notified until about the day of publication.

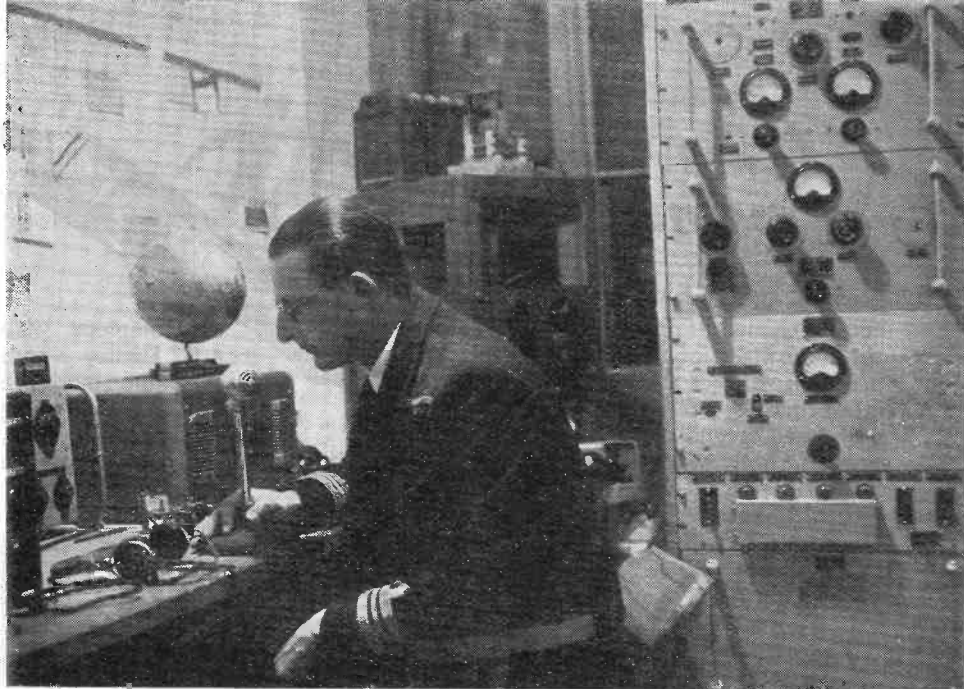

The other man's station

ZB1AB

READERS will be interested in this account of a station well known on the DX bands. Lt/Cdr. A. G. Chambers, R.N., who first opened ZB1A (as it then was) has himself had a wide experience of Amateur Radio. He is ex-VE5BP/G5NO and in the pre-war period also held the R.N.V(W).R. call MY4. He obtained his first licence as VE5BP in 1930, and, returning to this country, became G5NO in 1932. He was commissioned as a radar officer in the Royal Navy early in 1940. The following paragraphs are a description of the station in the words of Lt/Cdr. Chambers himself.

ZB1AB is located at the Port Radar Centre, H.M. Dockyard, Malta, and was first licensed in September of last year under the callsign ZB1A. The call was, however, changed to ZB1AB some weeks later by the local authorities because ZB1A was being pirated and steps were being taken to locate the offender.

ZB1AB is a true naval station, using modified naval equipment. Two transmitters are in use, one on 14 mc and the other on 28 mc; both can be operated on 'phone or CW. The licensed power is 100

watts, which is strictly adhered to, although the 14 mc job is being greatly under-run at this input.

The transmitting aerial normally used is a 66 ft. top 100 ft. high, zepp fed, which allows for a quick change to either band. A rotating beam has been built for 28 mc, but to date does not bring in better reports than the long wire, the only advantage being of course that it is more directional.

The first receiver to be used was an HRO; this was later exchanged for an AR-88, which is still in use. A Hallicrafter S-27 was also tried out on the 28 mc band, but was found to be too unselective.

There are two operators who both work 'phone or CW. The writer (who is also the owner of the station) regrets that he cannot possibly QSL all the SWL's who send in reports; if he did, he would require a secretary! It is hoped that SWL's will understand and excuse. QSL cards are sent, however, to all stations worked who particularly ask for the contact to be confirmed. This does *not* include the unfortunates who worked the pirate ZB1A!

Come to the point!



It's hot—all the time! That's because the heating element is housed **inside the bit** in the Solon Electric Soldering Iron. Soldering is easier; you get a neater, cleaner job in less time. All internal connections are housed at end of handle, away from heat. A robust cord grip prevents sharp bending of the flexible lead.

Complete with 6 ft. Henley 3-core flexible, Solon Irons are made for the following standard voltages—200/220, 230/250. Illustration shows a 125 watt standard model.



SOLON
Electric
SOLDERING IRON FOR INDUSTRIAL USE

W. T. HENLEY'S TELEGRAPH WORKS CO. LTD., Engineering Dept.
51-53 Hatton Garden, London, E.C.1

No matter what type of "tank circuit" YOU prefer in the "rig"

A compact assembly permitting the most efficient circuit layout. Condenser and coil base. Cat. No. E5009. Coils for 28, 14 and 7 mc/s.

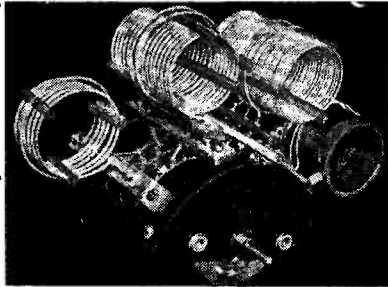

A Turret type 4-Band Coil Unit with Coils for 28, 14, 7 and 3.5 mc/s. A very neat assembly giving maximum flexibility. Complete, Cat. No. E5010. Switch and Bases only E5010A.

With any difficulty of supply please write direct to—

LABGEAR

Phone ||| 2494
Willow ||| Place,
CAMBRIDGE, ENG.

—For best results you must fit LABGEAR Quality Components

Double Ended P.A. Coil with swinging link coupling for front and rear control. Base Cat. No. E5004. Coils for 28, 14 and 7 mc/s.

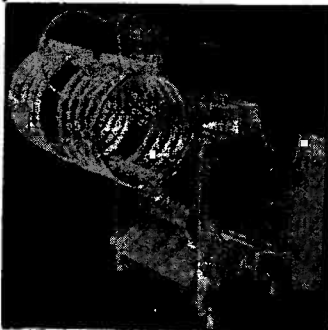
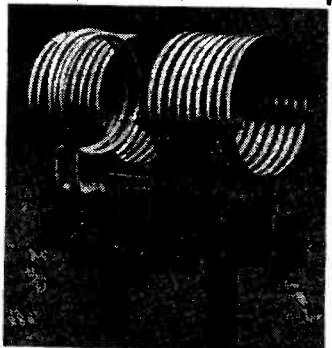

PREMIER RADIO

MORRIS AND CO. (RADIO) LTD.,

All Post Orders To: JUBILEE WORKS, 167 LOWER CLAPTON RD.,

LONDON, E.5.

(Amherst 4723)

Callers To: 169 FLEET STREET, E.C.4 (Central 2833)

OUR 1946 LIST IS NOW AVAILABLE. All enquiries must be accompanied by a 2½d. stamp.

2-VALVE SHORT-WAVE BATTERY KIT. A complete kit of parts for a 2-valve receiver, covering 15-600 metres, including valves, coils, drilled chassis, H.T. and L.T. dry batteries to last approximately 6 to 12 months. A pair of double headphones and full instructions. Price, £3 10s. An extra coil can be supplied, covering 600-1,900 metres at 4/-.

ALUMINIUM CHASSIS. Substantially made of bright aluminium, with four sides.

7×3½×2½" ...	4/6	9½×4½×2" ...	5/6
10×8×2½" ...	7/-	12×9×2½" ...	7/9
14×9×2½" ...	8/3	16×8×2½" ...	8/6
20×8×2½" ...	10/6	22×10×2½" ...	13/6

MOVING COIL METERS. By famous manufacturer. 500 microamps, 2" diam., 500 ohms. 21/-

SPECIAL OFFER. P.M. SPEAKERS AT HALF USUAL PRICES. 4", 17/6; 5", 15/-; 6", 17/6; 8", 20/-.

OUTPUT TRANSFORMERS for above, 6/-.

SUPER HEADPHONES. Corrugated aluminium diaphragms driven by balanced armature units, with nickel alloy magnets. The finest obtainable. Cost originally over £2.

60 ohms Resistance. 5/- per pair.

MATCHING TRANSFORMERS, if required. 2/6.

POWER PACKS. Complete with 2 H.W. rect. valves, and all smoothing. In steel cabinet. Output 650 volts, 100 m.a. Price 50/-.

VIBRATORS. 4-pin, 6 or 12 volt. Price 12/-.

TRANSFORMERS for same, 250 v. 60 m.a. 12/6.

VALVES AT LESS THAN HALF PRICE.

024, 7/6; 6K6, 6/-; 6F6, 6/-; EL35, 7/6.

DENCO C.T.1. TURRETS. Completely wired and aligned tuning packs, complete with tuning condenser. 16-50, 200-550, 800-2,000 metres. Available for 1-6 m/c or 465 k/c. Price 55/-.

DENCO C.T.3 TURRETS. Completely wired and aligned tuning packs, complete with 3-Gang Condenser, Dials and Knobs. Covers 10-2,000 metres in five bands. Incorporates an R.F. stage and band spread. All Denco packs incorporate Polystyrene Coil Formers. Iron Cores, Low loss Wavechange Switches. Price, £6/8/-.

PUSH-BUTTON UNITS, 5-way. Each switch is S.P.D.T. or S.P., one make, one break. Complete

with push-button and Escutcheon plate. 5/-.

VIBRATOR PACKS. With complete smoothing. 12 volts input, output 150 volts, 40 m.a. Contained in neat steel case, and is combined with a single valve amplifier. (No valve supplied.) Price, 35/-

MAINS TRANSFORMERS. Government surplus, super quality. All 230 volts input.

Type 1.—4-volt 10 amps. twice. 15/-.

Type 2.—40 volts 2 amps. (Excellent for rewind - ing). 15/-.

Type 3.—500-0-500, 150 m/a, 4 v. 2½ a., 4v. 1 a., 4 v. 5 a. 35/-.

Type 4.—865-0-865 v. Tapped at 760 and 690 v. 500 milliamps. Complete with L.T. trans. for rect. heaters, 4 v. 3-SA twice. Price, £5.

Type 5.—450-0-450. Tapped at 300 v. 150 m/a, 4 v. 3-5 a., 4 v. 3-5 a. 30/-.

Type 6.—15 v. at 60 amps. Tapped at 13-5, 14 and 14-5 v. L.T. winding easily stripped for rewinding up to 1 kilowatt. Price, 40/-.

Type 7.—6-3 v. 1-2 a., 4 v. 10a., 4 v. 10a., 4 v. 10a., 10 v. 8 a. 30/-.

TRANSFORMERS. 70-watt size. Useful for laminations. Only 4/- each. 40/- per dozen. Special quotations for large quantities.

SHORT-WAVE CONDENSERS. High-grade Ceramic insulation. Super Midget type. Single gangs available in 10, 20, 50, 75, 100 P.F. (75 P.F. has double spindle for ganging). Price 2/6.

2-GANG, in 4, 8, 9-6, 27-1, 50, 75 P.F. Price 5/-

2-GANG. Full size, 160 P.F. Price 5/-.

CYLDON 3-GANG. 50 + 50 + 25 P.F. Price 5/-

AIR-DIELECTRIC CERAMIC TRIMMERS, 25, 50, 100 P.F. Price 1/-.

PHILLIPS AIR DIELECTRIC CONCENTRIC TRIMMERS. 8 P.F. and 30 P.F. 1/- each.

WAVE CHANGE SWITCHES. Available with any of following Wafers. 2-pole, 3-way; 3-pole, 3-way; 4-pole, 2-way; 2-pole, 4-way; 1-pole, 4-way, with shorting bar; 2-pole, 5-way.

1-GANG 4/-; 2 GANG, 5/6; 3-GANG, 7/-.

SUPERHET TUNING PACKS. Completely wired and aligned. 13-40, 40-120, 190-570 metres. R.F. stage, 465 k.c.; 9 connections only. Complete with 3-gang Condenser, calibrated, engraved Perspex dial, and S/M drive. Litz wound polystyrene insulation permeability tuned I.F.'s, 7 k/c bandwidth. Price complete, £3/17/6.

'Q.5 R 9' PRODUCTS

(reg. trade mark)

Whilst much of our production is still on contract to retailers, we can now supply several factory-produced lines direct to the amateur under our own trade mark.

- ★ Specialized Components for amateurs, e.g. 6-band, 3-circuit revolving coil turret.
- ★ Finished Equipment, e.g. All purpose aerial coupling unit.
- ★ Aerial Equipment, e.g. Motor driven remote controlled 3-element, 5m. and 10m. beams.

Our April-June list is now ready, please send S.A.E. It may contain something of interest to you

EMDO LTD. Ace Works, Moor Lane, Staines

LONDEX for RELAYS

AERIAL CHANGE-OVER RELAY

for Radio-Frequency

Type AECO 4.

3 V.A. Coil Consumption, especially designed for Transmitters, High Frequency Heating, Amateur Stations, etc. Ask for leaflet 112/SW.



LONDEX LTD

MANUFACTURERS OF RELAYS

207 ANERLEY ROAD LONDON S.E.20

SYDENHAM
6258-9

**111 Pages
PACKED WITH INTEREST**

The most comprehensive Radio and Electronic Component Catalogue ever offered is yours for the asking. All lines are by well-known manufacturers including a complete valve range—No job clearance lines whatsoever.

A shilling postal order will bring you this catalogue post free.

SEND TO-DAY

B : T : S

63 London Road, Brighton 1, Sussex
Tel. : Brighton 1555

NEW DUAL TESTSCOPE



Ideal for
High and Low
Voltage Testing; 1/30

100/850 A.C. and D.C. Send for interesting leaflet L34 on Electrical and Radio Testing, from all Dealers or direct.

RUNBAKEN MANCHESTER-1

**EX-GOVERNMENT
WONDERFUL RADIO BARGAINS**
—offered at a Fraction of
Original Cost

**PACKARD-BELL
Microphone Pre-Amplifiers**

One twin triode 6SL7GT and one twin pentode 28D7. Input and Output transformer. Housed in aluminium case 5" x 3 1/2" x 3 1/2". A beautiful job.

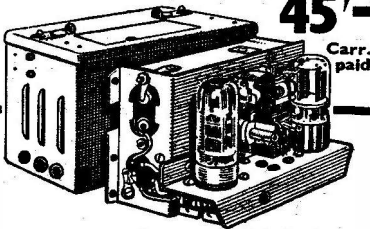

**WIRELESS
INSTRUMENTS**

(LEEDS) LTD.

54 & 56 THE HEADROW, LEEDS, 1

Tel. : 22262

ODEON RADIO

G4HV

P.A. Tank Assembly—Comprising split stator condenser, R.F. choke and by-pass condenser, neutralising condensers, and plug-in inductances of silver-plated copper tubing with swinging link, built into one compact unit, 5 1/2" x 5 1/2". Requires only a grid coil and condenser to make a complete 150 watt push-pull power amplifier.
Price complete with coils for 40, 20, 10 and 5 metre bands, £6/13/-.

Muirhead slow motion drives—50-1 reduction drive contained in 3" control knob, scale engraved round edge of knob. Fits 1/2" spindle. 15/-.

Transmitting Valves
Eimac 35T, £2
Hytron 807, 12/6

Tx. coil turret—Bandswitching unit by Labgear, with coils for 80, 40, 20, and 10 metre bands. Suitable for power inputs up to 150 watts. £5/17/6.

We are at present in a position to accept a limited number of orders for the construction of transmitters, amplifiers and "ham" gear in general, either to your design or our own, in addition to our normal service on the repair and realignment of communications receivers.

Appointed distributors of Eddystone, Labgear and Denco products.

56 COLLEGE ROAD, HARROW.
2 minutes from Harrow Met. Station

**1 1/2 METRE 10 VALVE
SUPERHET
UNITS**

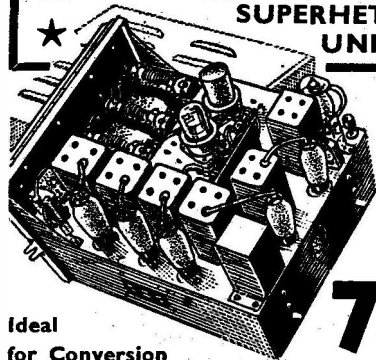

Ideal
for Conversion
into Television
Receivers

7 GNS

**CARRIAGE PAID,
CASH WITH ORDER**

Special discounts to Trade,
Radio Societies, etc., in lots
25 or more receivers.

Circuit Comprises—

1 Pre. Amp. Oscillator, Mixer. 5 I.F.'s., Detector and Video Amp. I.F. Frequency 12 Megs., Bandwidth 4 Megs. Co-axial input and output sockets. An external source of L.T. and H.T. is required. Manufactured to stringent Government specification by such famous makers as R.G.D., Murphy, Pye, etc. Complete with 10 Mazda Mains type valves 6.3 volt filaments. Unused and in manufacturers' sealed cartons.

AIS

40 Coil Pack

A superhet Coil Pack with an HF stage. Uses 9 iron-cored coils in a 16-50, 200-550 and 800-2,000 metres circuit for 465 kcs., I.F. Complete with circuit diagram, aligned and gain tested, this Coil Pack enables the amateur with no signal generator to construct a first-class all-wave receiver. Price £3/10/0. Circuit diagram only, 2/6 post free.

Model 30 TUNING HEART

Completely assembled and tested, this unit is built around the 30 Coil Pack covering 16-50, 200-550, 800-2,000 metres. Fitted with 6K8G, 6K7G and 6Q7G valves. Ideal for use with any amplifier. Requires 250 volts at 30 m/a and 6.3 volts at .9 amp. Price £9/9/0. Delivery approximately 6 weeks from date of order.

Once again we are giving a more detailed list of our standard products. All are manufactured and tested to conform to our usual high standard of technical excellence.

Receiver Kit

This famous 5-valve AC/DC Superhet Kit uses the 30 Coil Pack and thus provides excellent reception on all bands. All components included plus 3 blue-prints giving full constructional information. Price £12/1/11. An attractive oak veneered cabinet is available to house this receiver. Price 55/-.

A.I.S. Tuning Scale

Manufactured exclusively for A.I.S. and bearing our name. Attractively designed and colour printed on metal. Size 8 1/2" x 6". For use with 30, 30D and 40 Coil Packs. Price 5/-.

X A.I.S. CIRCUITS

6-valve AC mains superhet using 40 Coil Pack. 3 constructional drawings and priced Parts List, 3/6 per set. The same, but for AC/DC operation, 3/6 per set. 5-valve AC mains superhet using 30 Coil Pack. 3 constructional drawings and priced Parts List, 3/6 per set. The same, but for AC/DC operation, 3/6 per set. These drawings show how to make the best use of our Coil Packs.

30 Coil Pack Series

A famous series of precision made Coil Packs now too well known to need description. Superhet types; Model 30, 16-50, 200-550, 800-2,000 at 42/-; 30A, 12-30, 30-75, 75-200 at 42/-; 30B, 16-50, 200-550, at 30/-; 30C, 200-550, 800-2,000 at 30/-; 30S, 12-30, 30-75, 200-550 at 42/-. TRF types: Model 30D, 16-50, 200-550, 800-2,000 at 35/-; 30E, 12-30, 30-75, 75-200 at 35/-; 30F, 16-50, 200-550 at 27/6; 30G, 200-550, 800-2,000 at 27/6. Each is complete with circuit diagram. Circuits only 2/6 each.

High Q' I.F. Transformers

465 kcs. Iron cored, permeability tuned. Recommended for use with Coil Packs 40, 30, 30A, 30B, 30C and 30S. Aligned and gain tested. Price 17/6 per pair.

MANY OTHER INTERESTING A.I.S. PRODUCTS ARE AVAILABLE. SEND STAMP FOR NEW PRICE LIST. NO C.O.D. UNDER £2.



ALIGNED INSTRUMENTS SERVICES

1 Colworth Rd., Leytonstone, E.11

G 80 G

BERT DOBSON

Post orders despatched by return. Please do not include cash with order. We prefer to send C.O.D.

We have all the parts for the Eddystone Converter in stock, including the screens. These are all ready cut and drilled, are nickel-plated and comprise five in number, price 14/3 the set. All other Eddystone components, chassis, cabinets, etc., in stock.

Woden Transformers—1,250 v, 750 v, 650 v
Woden Chokes, 12 hy. 60mils, 12hy. 150 mils 5/25hy. 250mils, 5/25hy. 150 mils, etc., etc. In stock at list prices.

Static Condensers—2mfd 1,000v wkg, 11/7 ; 8mfd. 1,000v wkg, 29/6 ; 2mfd 2,000v wkg, 22/6.

ERG Bleeder Resistors—50 watt 25,000 ohms, 7/6 ; 50 watt 50,000 ohms, 8/- ; 100 watt 50,000 ohms, 10/-, etc., etc.

Dubilier 30 Watt Resistors—500, 1,000, 1,500, 2,000 and 10,000 ohms, all 4/6 each. 7,500 ohm 3 watt Resistors (carbon), 2/6 each.

Celestion, Amphenol, Ceramic Valve Holders, in three types :—
(a) Octal International, (b) American 4-pin, (c) American 5-pin. Each 3/6 List.

6 GRAND ARCADE, LEEDS, 1

Tel.: 22175

G 80 G

Varley

Products of Quality & Reliability

MAINS TRANSFORMERS
A. F. TRANSFORMERS
SMOOTHING CHOKES
THERMAL DELAY SWITCHES
POWER RESISTANCES

Made by

OLIVER PELL CONTROL LTD

Telephone: WOOLWICH 1422
CAMBRIDGE ROW WOOLWICH S E 18

RADIO CLEARANCE LTD.

27 TOTTENHAM COURT ROAD, W.I.

MUS 9188

American S.W. Sets—Covering 3·1 to 15·5 Mc/s in 3 bands. 4-valve superhet, complete with power pack for 6v batt. or 90/250v A.C. 50 c/s, headphones, mains leads, batt. leads, etc. £8/8 complete.

Universal Test Meters—Limited number Ferranti. £6/6/-; B.P.L., £5/15/-.

Mains Trans.—Outputs 3kv 30mA (5Kv no load), 300v 250 mA, 4v 20A, 6·3v 4·2A, 4v 1·2A, for C.R.T. 3-valve holders for rect. mounted and wired ready for use. Primary 230v, 50 c/s., 30/-.

Heavy Duty Smoothing Chokes—400mA, 250Ω, 21/-.

Smoothing Chokes—20H, 80mA, 300Ω, 12/6.

P.M. Speakers—All well-known makes, 2½", 3½", 5", 25/-; 8" less trans., 25/-; with trans., 27/6; 10" with trans., 42/6; less trans., 40/-.

3-Gang Condensers—0005 Ceramic ins., 7/6.

Volume Controls—With SW, 5K, 10K, 25K, 50K, 100K, 250K, 500K, 1M, 5/3.

Volume Controls—Carbon, less SW, 50K, 100K, 500K, 1M, 2/6. Double 1M, 4/- (ganged).

Volume Controls Wire Wound—3W, 100Ω, 200Ω, 500Ω, 1K, 2K, 5K, 10K, 20K, 50K, 2/6.

Volume Controls Miniature—1K, 20K, 100K, 200K, 500K, 2/-.

Mansbridge Condensers—1MF 350v, 8d.; 1,000v, 1/3; 2MF 300v, 1/-; 4MF 600v, 4/6; 4MF 1,500v, 5/-.

Tubular Condensers—001, 005, .01 1,000v, 6d. .02, .05, 500v, 6d. .1 350v, 7d.

Tubular Condensers, Bakelised, .17 250v, 3d. .1 600v, 6d. 100MF 12v Electrolytic, 1/-.

Mica Condensers—0001-3·5, 4d.; .001-2·4·5, 5d.; .01, 6d.

Silver Mica Condensers—Most values 5pF-6,000pF, 6d.

Ceramic Condensers—2pF, 10pF, 20pF, 25pF, 50pF, 100pF, 6d.

Resistors—¼W, 3d.; ½W, 4d.; 1W, 6d.; 2W, 10d.; 3W, 1/3. Most values available.

Resistors, Vitreous—W/E, 3W, 5Ω, 45Ω, 470Ω, 3·9K, 6·8K, 47K, 1/-.

Resistors, Vitreous—10W, 50Ω, 250Ω, 500, 1K, 1/6; 20W, 120Ω, 200Ω, 2K, 8K, 2/-; 25W; 350Ω, 5K, 2/6; 40W 14K tapped at 2K, 3/-.

Valve Holders—4P Brit. Pax, 1d. Amphenol, 4PUX, 5PUX, 5P Brit., Mazda Oct., 6d. Int. Oct., 8d. Ceramic 5PUX, 7PUX, 1/6. EF50, etc., PAX 6d.; Micalox, 1/-, Ceramic 1/6.

Ceramic Trimmers—1-15pF, 3-50pF, 9d.

Padders—150pF, 750-1250pF, 1/-

Air Spaced Variable—¾" Spindle, 30pF, 1/-.

U.H.F. Chokes—1/- Wire ended.

Television Line Trans.—12/-.

Output Trans.—Tropicalised C.T. SEC, giving ratios 30 and 15 to 1, 4/-.

Moving Coil Headphones—Slightly used, 10/6 pair.

Power Carb Mikes—With switch in handle, 10/6.

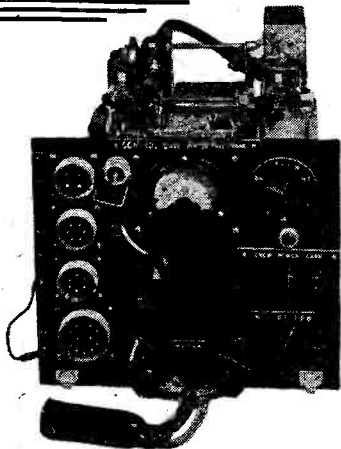

CONTROL UNITS

Meter 0-500 Micro Amps M.C. Valves 2 EL32 and 2 EF 36. Resistances, condensers, transformers, metal rect., switches, vol. controls, etc. ONLY £3/17/6. Carriage paid.

MAXWELLS LTD.

321 ARGYLE STREET, GLASGOW, C.2

Telegrams: "Maxrad," Glasgow

SOUTHERN RADIO AND ELECTRICAL SUPPLIES

IMMEDIATE DELIVERY for early orders

● **EDDYSTONE**—New Miniature Speaker for communication and extension work. This is the finest miniature speaker we have seen and is typical Eddy-stone quality. Solid diecast circular cabinet in ripple grey approximately 5½" diameter, fitted with very efficient 3½" permanent magnet loudspeaker. See illustration on page 3 last issue. £3/7/6.

Short Wave Manual No. 5. Full of practical details of construction of transmitters, receivers, converters, etc. 2/6 or 2/7 post free.

Low Loss Microcondensers—20pF, 6/-; 40pF, 6/6; 60pF, 7/-; 100pF, 7/11; 160pF, 8/3. **Low Loss 6-pin Coil Formers**, 1½" diam., plain 3/-, threaded 14 t.p.i. 3/3. **Slow Motion Dials**. Full Vision Dial for individual calibration, 19/9; Cat. 597 Miniature Precision S.M. Dial, 2" diam., black finish, 13/6; Cat. 637, 3½" diam. 20/-; Cat. 594, as 637, but with black finish, 17/6. All above dials are 10 to 1 ratio.

● **BULGIN**—Red Signal lamps, panel fitting for TX, etc., 2/6. 5-pin cable plug fits British 5-pin valve-holder, 3/-.

● **AVO**—D.C. Avo-minor, 15 ranges, tests up to: 600v, 120mA, and 3 megohms, 84/-; Universal Avo-minor, 16 ranges, tests up to 500v A.C. and D.C., 500mA D.C., and 10 megohms, £8/10/-.

Universal Avo-meter, Model 40., 41 ranges, tests up to 1,200v, A.C. and D.C., 12 amps A.C. and D.C., and 1 megohm with large scale length on very low resistances, £17/10.

● **DENCO**—B.F.O. Units. Complete unit requiring triode valve only 13/9. 465 Kcs or 1·6 Mcs.

Please include postage on all orders under £2.

800 Line Illustrated Catalogue 6d. Stamp Post Free.

85 FISHERTON ST., SALISBURY, WILTS.

Telephone: Salisbury 2108.



The CRITERION amongst GOOD TRANSFORMERS

The prices shown below are the current list prices and include the increase effective from November 1, 1946. Please send for complete revised Price List.

MULTIMATCH MODULATION TRANSFORMERS



Woden engineers have developed a special range of Multimatch modulation transformers for Amateur Transmitting use, details of which are given below. The transformers are vacuum impregnated and fitted in compound-filled steel pots giving reliable and silent working.

Primary impedances, 2,000/18,000 ohms. Secondary impedances, 200/20,000 ohms.

- TYPE U.M.1. Suitable for 30 watts Audio. Max. Sec. current, 120 m/a 38/5
- TYPE U.M.2. Suitable for 60-watts Audio. Max. Sec. current, 200 m/a 51/-
- TYPE U.M.3. Suitable for 125 watts Audio. Max. Sec. current, 250 m/a 73/2

Larger sizes to order.

DE LUXE TYPE TRANSFORMERS AND CHOKES

This entirely new range of transformers and chokes housed in streamlined die-cast cases enable equipment to be constructed setting a standard not hitherto attained. Full details are given in our lists and a representative range is given below.

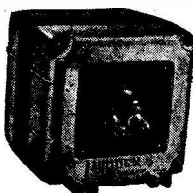

MAINS TRANSFORMERS

- | | |
|-----------------------------------|---|
| D.T.M.11. 250-0-250 60 m/a 32/5 | D.T.M.16. 650-0-650 200 m/a 67/9 |
| D.T.M.12. 275-0-275 120 m/a 46/10 | D.T.M.17. 750-0-750 250 m/a 98/5 |
| D.T.M.13. 350-0-350 120 m/a 50/5 | D.T.M.18. 1250-1000-0-1000-1250 300 m/a 150/- |
| D.T.M.14. 425-0-425 150 m/a 58/6 | D.T.M.19. 1500-0-1500 350 m/a 169/2 |
| D.T.M.15. 500-0-500 150 m/a 58/6 | D.T.M.20. 2000-0-2000 350 m/a 192/- |

FILAMENT TRANSFORMERS

- | | |
|-------------------------------------|-----------------------------------|
| D.T.F.11. 2.5 v. 5 amp. C.T. 27/- | D.T.F.17. 7.5 v. 5 amp. C.T. 30/8 |
| D.T.F.12. 2.5 v. 10 amp. C.T. 34/10 | D.T.F.18. 5 v. 3 amp. C.T. 31/9 |
| D.T.F.13. 4 v. 10 amp. C.T. 36/7 | D.T.F.19. 4 v. 4 amp. C.T. 31/9 |
| D.T.F.14. 5 v. 4 amp. C.T. 27/- | D.T.F.19. 4 v. 2.5 amp. C.T. 31/9 |
| D.T.F.15. 6.3 v. 4 amp. C.T. 27/- | D.T.F.20. 10 v. 6 amp. C.T. 51/7 |
| D.T.F.16. 4 v. 6 amp. C.T. 27/- | |

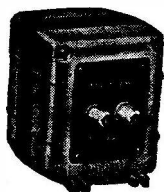

SMOOTHING CHOKES

- | | |
|--|--|
| D.C.S. 11. 12 Hy 60 m/a. D.C. Resist. 550 ohms 17/10 | |
| D.C.S. 12. 12 Hy 150 m/a. D.C. Resist. 190 ohms 25/- | |
| D.C.S. 13. 12 Hy 250 m/a. D.C. Resist. 180 ohms 51/7 | |
| D.C.S. 14. 12 Hy 350 m/a. D.C. Resist. 60 ohms 44/10 | |
| D.C.S. 15. 12 Hy 500 m/a. D.C. Resist. 80 ohms 103/2 | |
| D.C.S. 16. 12 or 60 Hy 100 or 50 m/a. D.C. Resist. 250 ohms or 1,100 ohms 25/- | |

WAVEMETERS EX-GOVT. CLASS D, No. 1, MK. II

Ranges 1900-4000 Kcs, 4000-8000 Kcs, with check frequencies up to 25 Mcs. Employs twin crystal, 100/1000 Kcs, and ensures ± 2 Kcs. accuracy. Operated from 6v battery, but conversion to 6v A.C. operation extremely simple. Details on request. BRAND NEW and UNUSED, in Original Army Teak Carrying Case, complete with Instruction Book and SPARE VALVE and SPARE VIBRATOR, only £6/15/-, or a few only without spares at 85/- (carriage 3/6). Illustrated leaflet available.

EX-R.A.F. "IDENTIFICATION FRIEND OR FOE" RADAR R3003 TRANSMITTER RECEIVERS

Operates between 155-185 Mcs. Complete with 10 valves as follows : 2-type RK34, 1-type EF50, 4-type SP41, 3-type DI, and 20 watts motor generator, 24v input, 480 volts, 40 ma output. Easily convertible for amateur use. Model R3002 for 12v operation also available. Only 79/6 (carriage 4/-).

Post Orders Only, C.W.O. S.A.E. brings current lists.

U.E.I. CORP., 32 St. Gabriel's Road, London, N.W.2

SAMSON SURPLUS STORES

Tel. : PAD 7851

169-171 Edgware Road, London, W.2

Open all day Saturday. No C.O.D. under £2.

Postage extra on all orders

Ex-Army 208 Reception Receivers—6v Superhet built in strong metal cabinet, for 6 volts and 100-250v A.C. freq. range, 5-30 metres. Complete with spare valves, phones and self-contained speaker, £27/10/-.

Ex-Army 109 Reception Set for 6 Volts—8-valve Superhet, complete with spare valves and vibrator, and self-contained speaker, freq. range 12-2 mc/s, £14/10/-.. Lightweight model as above, less speaker, £12/10/-..

Thermo Ampmeter—0-4A 2½" dial in rectangle bakelite case, with shorting switch, 27/6. A.C. meter 2½", 0-150/300 volts, with external resistance box, 39/6 ; 0-150 M/A, 27/6 ; 0-30 M/A, 2½", 27/6 ; 0-500 M/A, 3", 27/6.

S.T.C. L.T. Rectifiers—12v 25 amps, £5/10/- ; 12v 3 amps, 22/6 ; 12v 1 amp, 12/6 ; 6v ½ amp, 8/6. Miniature Ceramic Button V/ Holders, 1/3. Miniature Valve Screens, 1/9. Ceramic E.F.50 V/ Holders, 1/9.

Ex-Army No. 38 5v Battery Trans-Receivers—Freq. 7-4.9 mc/s, complete with standard 2v valves, and junc. box, 55/-.. Spares : Set of 3 valves in metal container, 15/-.. Headphones, 10/-.. Throat mikes, 7/6. Haversacks, 4/9. Rod aertials, 4 lengths in canvas case, 12/6. All accessories sold separately if desired.

Brand New Admiralty Indicators built in Metal Case—Complete unit with C.R. tube V.C.R.97, and 7 valves, 500 cycles time base. Suitable for oscilloscope construction, £12/10/-..

Just Arrived—The following meters, all new, and by well-known makers : 0-1 Milliamp M/coil 2½" dial. Mounted in sloping bakelite case with terminals, 39/6.

REGARDING DESIGN, re-design, or modifications to your communications equipment :—

Phone : BAY 6780, or call.

A. & H. WHITE

Radio Development Engineers

105/107 TALBOT ROAD,
LONDON, W.II

H.A.C.

Short-Wave Equipment

Noted for over 15 years for
Short-Wave Receivers and Kits of quality

One Valve Kit, Model "C" Price 20/-
Two " " " " "E" " 43/-

These kits are complete with all components, accessories, and full instructions. Before ordering send stamped addressed envelope for descriptive catalogue.

Note new sole address :—

"H.A.C." SHORT-WAVE PRODUCTS
(Dept. VIC.) 66 New Bond St., London, W.1

AMATEUR RADIO GEAR

We are specialists in amateur and experimental radio gear and can offer from stock some very advanced instruments by famous American and British manufacturers.

LABGEAR—Crystal frequency standards, oscilloscopes, power packs, absorption meters, transmitting inductances.

I.E.C.—Special 30-valve oscilloscopes, heterodyne audio oscillators, 100 m/cs. frequency standards.

R.C.A.—800-1,000 m/cs. transceiver, 50 gns.

EDDYSTONE—Components.

Several small transceivers, American specification, 200-240 m/cs., 8 tubes, 1 year's guarantee, 25 gns. 5 and 10 Metre bands transmitter push-pull output, 15 watts, A.C. mains or mobile operation, 15 gns.

Audio Amplifiers, 5 watt, chassis model, 85/-, new and guaranteed; 15 watt, enclosed steel cabinet, 18 gns.; high quality 15 watt, 29 gns.

American GT and special valves.

22-page Catalogue, price 6d.

ADAMS RADIO SUPPLIES, GZHHK
655 Fulham Road, London, S.W.6
RENow 4178

SHORT WAVE (HULL) RADIO

G5GX

Stockists of Eddystone, Q Max, Labgear, Raymart, Woden, QCC, etc.

Once more we offer the following kits :-

RECEIVERS

1 V.2 Battery operated, 9-200 metres £10 0 0
1 (Tuned) V.2 Battery operated,
9-200 metres 12 12 0

All the above complete with black crackle steel cabinet, coils and valves, but less batteries and speaker.

TRANSMITTERS

V.F.O. (Franklin) complete and air-
tested, less power pack £12 12 0
10 watt C.W. Tx. 12 12 0
25 watt C.W. Tx. 27 10 0
75 watt C.W. Tx. 32 10 0
140 watt C.W. Tx. 40 0 0

The above transmitters are complete with crystal and coils for one band only.

Further details supplied on request

SHORT WAVE (HULL) RADIO

30/32 Prince's Avenue,
HULL
Telephone : 7168

PERFORMANCE THAT COUNTS!

THE V55R COMMUNICATION RECEIVER
HAS A SENSITIVITY OF 1 MICROVOLT
ON ALL BANDS

THE 510 EXPANDER, A HIGH PERFORMANCE
HF CONVERTER, COVERING THE 5 AND 10
METRE AMATEUR BANDS, HAS A SENSITIVITY
OF BETTER THAN 1 MICROVOLT ON THE
10 METRE BAND, AND 1 MICROVOLT ON
THE 5 METRE BAND

Phone : 20167

Illustrated Literature from :
RADIOVISION (Leicester) LTD.
58-60 RUTLAND ST., LEICESTER

CLASSIFIED SMALL ADVERTISEMENTS

TRADE ADVERTISEMENTS

9d. per word, minimum charge 12/-. No series discounts; all charges payable with order. Insertions of Radio interest only accepted. Add 25% for Bold Face (Heavy Type).

A COMPLETE LIST OF SW STATIONS W/ ALENGTH AND FREQUENCY ACCURATELY COMPILED. PRICE 2/3—HANDYSHOP, 109a CHURCH STREET, CROYDON.

ALUMINIUM chassis and panels from 3/9. Plain or punched for valveholders, etc. Prompt delivery, E.A.D., 13 Bence Lane, Darton, Barnsley.

WE HAVE THE LARGEST STOCK OF ENGLISH AND AMERICAN RADIO BOOKS IN THE COUNTRY, INCLUDING MANY NOW OUT OF PRINT. Write or call for List, Modern Book Co., 19/23 Praed Street (Dept. V), London, W.2. Pad. 4185.

QSL CARDS AND LOG BOOKS, APPROVED G.P.O. SAMPLES FREE. ATKINSON BROS., PRINTERS, ELLAND, YORKS.

SPECIAL OFFER. Assorted condensers, .001 to .5 MF, mostly metal cased. 5/3 doz. Good assortment Resistors $\frac{1}{2}$, $\frac{1}{4}$ and 1 watt 2/- doz. Carbon Microphones, hand-type with on-off switch, lead and socket, 7/6 each, postage extra. S.A.E. with all enquiries, please.—KEMP, BCM/KRAE, London, W.C.1.

COMPLETE wireless station ideal "Field Day" outfit. Price and details on request.—J. Bull (Ruislip), Ltd., 42-46 Windmill Hill, Ruislip, Middlesex. COMPONENTS, complete equipment, prompt deliveries. The nearest Transmitters you ever set eyes on, meter switching, band-switching, covering all bands. Prices from £26 10s. complete. S.A.E. Lists.—Amateur Radio Service, G6HP, Canning Street, Burnley, Lancs.

KIT Sets: 4v TRF, AC-DC, L & MW bands, Rola KLS, BVA valves, Superb cabinet—everything included down to the last screw! Full instructions and Guarantee enclosed with each kit. Price £119/7d. (Carriage 2/6d. extra) A real quality job equal to any Factory built set, at a saving of at least £5! Cash with Order.—Johnsons (Radio), Macclesfield, Cheshire (G3AFH).

A LIMITED number of meter-rectifiers by Westinghouse, new midjet, tubular, $\frac{1}{2}$ " x $\frac{3}{8}$ " tag ends, half-wave, 3/- each.—G2CDN, 87 Brixton Hill, S.W.2.

METAL VALVES. OZ4, 6K7, 6J7, 6F6, 12SR7, 12SF5, also 83 and 807. Few American three and four-gang condensers.—Portland Radio, 105 Bolsover Street, London, W.1.

HRO BANDSPREAD COILS REQUIRED. WRITE BOX NO. 122, S. W. Magazine, 49 Victoria Street, S.W.1.

STUDDING: Standard assortment brass or steel, 4 12" lengths 2, 4, 6, 8, BA 9/-. SCREWS: Gross assorted 2, 4, 6, BA 3/-. NUTS: ditto, 3/-. Postage extra. Manufacturers, large users quoted. Comprehensive list screws, nuts, studding, terminals, P.V.C. wire, sleeving, etc., 1d.—WEST LONDON SERVICE COMPANY, 32 Shepherds Bush Place, W.12, CHISWICK 1419.

VFO DRIVE Unit or QRP Transmitter on 160, 80 or 40 metres 10/15 watts RF. Can be plugged into average crystal holder without circuit changes. Price £21 10 0. Ready to put on air. Full particulars and photographs, 1/-, returnable. Delivery in rotation.—G2IX, Radio Maintenance, 111 Queens Road, Leicester. Tel 78294.

READERS' ADVERTISEMENTS

3d. per word, min. charge 5/-, payable with order

EDDYSTONE 358x, 32 mc to 90 kc, 9 Coils. As new. Just overhauled and relined, £45.—38 Market Place, N.W.11. SPE 4486.

COMPLETE STATION must be sold: Comprising 150-watt rack-built 'phone and CW Transmitter with all accessories; HRO Senior Receiver. Guaranteed in perfect working order. Best offer above £200 secures.—Box 118, S.W.M., 49 Victoria Street, London, S.W.1.

ACORN pentodes type 954, new and complete with ceramic bases, 25/- each.—Rawston, 155 London Road South, Lowestoft, Suffolk.

SUPER Skyrider SX-16. As new, completely overhauled Webb's Radio. With 2 Magnavox mains speakers giving high fidelity reproduction. Best offer over £50.—Box No. 119, S.W.M., 49 Victoria Street, London, S.W.1.

1946 HALLICRAFTER SX41W, 28 mc to 550 kc continuous, electrical bandspread, BFO, ANL, built-in speaker, phone provision, metal cabinet, 110 or 230 AC/DC. £17.—Box No. 120, S.W.M., 49 Victoria Street, London, S.W.1.

FOR SALE. Hallicrafters communication receiver. S-29. AC/DC or Battery. 540 kc-30 mc. Electrical bandspread, ANL, AVC, BFO, standby switch, AF gain, RF gain, band switch and power switch. Built-in speaker and telescopic aerial. Excellent condition £30.—G5SG, 6 Axholme Avenue, Burnt Oak, Edgware, Middlesex. G6PJ has for disposal—Trophy 6, and ham-built Gpreselector, FB JOB. Valves, Crystals, and many items. Enquiries, 124 Nicholson Road, Sheffield.

SELL—G5GQ Surplus. HK354 (rated up to 1 kW output) with 5v 10 amp. filament transformer, £2 10s, Foster 2000-0-2000v, $\frac{1}{2}$ amp. transformer, real power house job, £6. Pair of 203Z modulators (350 watts) used 30 hours only. £3 10s. Brand new HK24, £1, 1250-0-1250v, 300 mA transformer, £2 10s. Two genuine Hammarlund 7,500v. tank condensers, 30 μ F, £1 5s. each. Three 50-watt valve holders, 5/- each. London area. Box 121, S.W.M., 49 Victoria Street, S.W.1.

SURPLUS American valves for sale, 1625, 10/-; 1626, 7/6; 1629, 7/6; 28D7, 5/-; 6SL7, 5/-.—The lot: 30/-. Offers for 60 issues Practical Wireless—Jarvis, Eastgate, Marham, King's Lynn.

EXCHANGE for binoculars, Pvc Receiver Battery, Two Philips AC 6 valve Chassis OK, Mains, Intervalve Transformers, Chokes, Valves, Sundry Components. Box No. 123.

WANTED. Communications receiver. Please send full details, frequency range, price, etc., to BR5 9805, 48 Consort Road, Peckham, London, S.E.15.

MORSE CODE Training

FOR BEGINNERS
AND OPERATORS

IRREFUTABLE EVIDENCE

of the value of the Candler System of Morse Code training is given in the "extracts from students' letters" sent with every copy of the Candler.

"BOOK OF FACTS"

This book is sent post free. It gives full details of the following courses.

JUNIOR Scientific Code Course for beginners. Teaches all the necessary code fundamentals scientifically.

ADVANCED High-speed Telegraphing for operators who want to increase their w.p.m. speed and improve their technique.

TELEGRAPH Touch Type-writing for speedy recording of messages and for general commercial uses. Here is one example of the value of the Candler System of training.

REMARKABLE PROGRESSIONS. "I suppose it seems very unusual to be sending you all the reports on Lessons 3 to 10 together in one letter. I have done this so that you may see the series of remarkable progressions I have made with each lesson. I had no knowledge of Code before taking the Candler Junior Course. Now I have a perfectly spaced sending speed of 26 w.p.m., and a receiving speed of 25 w.p.m. A few weeks ago I obtained my P.M.G. Special Certificate, and I am going to sea very shortly as a 2nd Radio Officer."—Ref. No. 7925.—A.H.M.

Code Courses on Cash or Monthly Payment Terms.
WRITE NOW FOR THE FREE "BOOK OF FACTS."

THE CANDLER SYSTEM CO.

(55 "S.W."), 121 Kingsway, London, W.C.2.
Candler System Co., Denver, Colorado, U.S.A.

THE RIII6 COMMUNICATIONS RECEIVER

Ex-R.A.F.

Made by famous British Manufacturers
Standard Telephones, Philco, etc.

**COMPLETE WITH 8 VALVES, POWER
SUPPLY REQUIRED (H.T. 120V, L.T. 2V)**

FREQUENCY COVERAGE

- Range 1, 142—315 Kcs.
- Range 2, 315—700 Kcs.
- Range 3, 700—1,600 Kcs.
- Range 4, 2—4.4 Mcs.
- Range 5, 4.4—7.3 Mcs.
- Range 6, 7.3—12 Mcs.
- Range 7, 12—20 Mcs.

(Band-switching)

ONLY **£3 : 10 : 0** Carriage and Packing 10/6

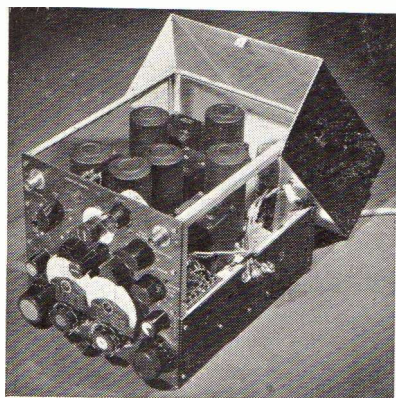

MARCONI MCRI POWER PACKS

£3 : 0 : 0

(Carriage 1/2)

To purchasers of the famous Resistance Movement MCRI Receiver only, we are able to offer the complete A.C./D.C. miniature power pack at the very lowest cost. Suitable for all types of mains voltages. Comprehensive circuit diagrams, component values, physical layout, etc., for the MCRI now available at 2/9 post free.

TRANSMITTER RECEIVER UNITS

RADAR IFF UNITS

Several different types of these have now become available

79/6 each

(Carriage and packing 5/-)

R3002—10 Valves supplied : 4 SP41, 2 RK34, 1 EF50, 3 D1. 12v input rotary transformer, 480v 40 m/a output. Frequency coverage, 22-85 mcs.

R3109—8 Valves supplied : 4 SP41, 2 E1148, 2 D1. 24v input rotary transformer, 480v 40 m/a output. Frequency coverage 38-52, 194-220 mcs.

R3090—10 Valves supplied : 2 6J.PGT, 4 SP41, 1 EB34, 2 E1148, 1 EA50, 24v input rotary transformer, 480v-40 m/a output. Frequency coverage, 38-52, 194-220 mcs.

MODULATION METERS

(Indicators
Modulation
Type 2)

65/0

Carriage paid

Complete in metal carrying case, 11½" × 7¼" × 6¼", with 0-500 microamps D.C. moving coil meter, calibrated for percentage modulation. Frequency 2.4-6.2 mcs.

Valve 6/9 extra. An easily convertible valve volt-meter.

WAVEMETERS CLASS D

£2 : 12 : 6 (Carriage 2/6)

The famous Class D No. 1 Mk. II Wavemeter is again offered complete with Xtal, less valve and vibrator at a very low figure.

Spares available ECH35 valves, 12/6; vibrators, 15/-. Instruction books, 5/-. Wooden transit case, 5/-.

M.O.S.

Send stamp for illustrated catalogue.

MAIL ORDER SUPPLY CO.,
24 NEW ROAD, LONDON, E.1

Stepney Green 2760.

Everything for the serious amateur!

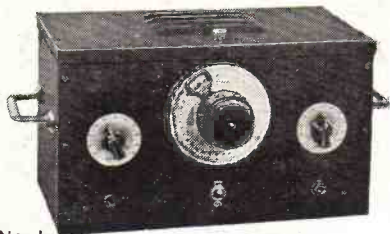

No. 1

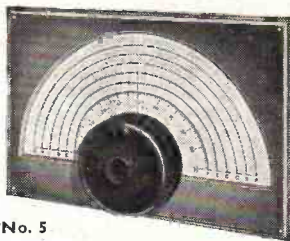

No. 5



No. 2.

"Q-MAX" S. W. ALL DRY 4

No. 1. All-dry short wave receiver from 11 to 250 metres and using plug-in coils. £12.12.0. P.T. £2.17.5

MINIATURE SIGNAL LAMP INDICATORS

No. 2. In green, blue, red, or white . . . 1/9

H.F. CHOKES

QH F3 Induct. 1.3 mH ; D.C. res. 20 ohms ; Max. D.C. 3/3

Curr. 100mA QH F4 Induct. 5.5.H; D.C. res. 1.4 ohms; 2/3

SLOW MOTION DIALS

No. 4. Full Vision S. M. Dials for individual calibration. Dial engraved 5 blank scales and 1 calibrated 0-180°, glass and escutcheon and knob. 6½" x 3½" 15/6

(Dial only 3/-)

No. 5. SMDB. 50-1. Precision Slow Motion Drive (dial 9½" x 6½"). For communication type Receivers (0-100°) 66/- (Dial only 6/6)

"Q-MAX" CHASSIS CUTTERS

No. 6. Holes cut easily and cleanly, without distortion of the metal. 1½" (Octal) . . . 10/6 1½" and 1¼" . . . 12/6

(Postage 9d. extra)



No. 6 (Patent applied for)

ABSORPTION WAVEMETER AND PHONE MONITOR

No. 7. All amateur bands are covered by means of plug-in inductances 35/-

No. 8. Flexible Driving Shafts with panel bush. 5½" each 6/- 8½" each 6/6



No. 7

JUST OUT!

The "Q-MAX" VHF CONVERTOR

embodying circuit refinements not found in any other make plus advantages of—

MONO-UNIT COILS

Full Vision Calibrated Scale One knob tuning and Extra Top Band Coil Range. Price (with 30 Mc/s or 56 Mc/s Coil Unit) 19 Guineas. (Extra Coil Units 30/- each.)

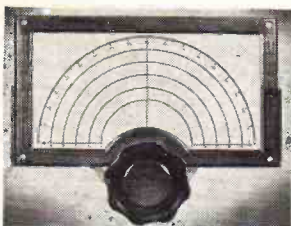

No. 4

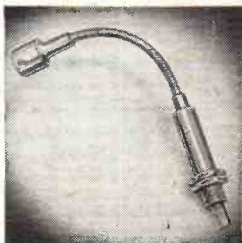

No. 8

"R" METERS FOR AR88 - - 59/6

Obtainable from your dealer or direct from:-

BERRY'S
(SHORT WAVE) LTD
25, HIGH HOLBORN, LONDON, W. C. 1
OPPOSITE CHANCERY LANE
TELEPHONE: HOLBORN 6231

Illustrated Catalogue 6^p post free



RA**D**I**O** manufacturers, service engineers, workshop and laboratory technicians are familiar with the precision and dependability of "AVO" Electrical Testing Instruments. Long years of successful experience in the design and manufacture of first-grade instruments have produced a consistently high standard of accuracy which has become a tradition as well as a standard by which other instruments are frequently judged.

Write for pamphlet descriptive of the "AVO" Instruments illustrated above.

A Fine Achievement

in Radio Reception has been attained by the latest S. G. BROWN, Type K

MOVING COIL HEADPHONES

Where High Fidelity Reproduction is required, such as for DX work, Monitoring and Laboratory purposes, etc., these precision-built Moving Coil Headphones will be highly appreciated.

Technical Details :

D.C. RESISTANCE—94 ohms per pair
 IMPEDANCE—104 ohms @ 1,000 c.p.s.
 SENSITIVITY—8Dbs. above 1 microwatt per bar @ 1,000 c.p.s.

PRICE £5 . 5 . 0 PER PAIR

S.G. Brown, Ltd.

VICTORIA RD., NORTH ACTON, LONDON, W.3 'Phone: ACOrn 5021



DESCRIPTIVE BROCHURE "S.W.K." will be sent free on request. For details of other S. G. Brown Headphones (prices from 25/- to 60/-) ask for Brochure "S.W."

Offers worth noting!



HEADPHONES. Phones are needed for short wave experiments, and we can offer a special line of ex. G.P.O. double headphones, high resistance, light-weight type S.G.B., as new, double headband and cord, 23/-; Low Resistance Single headphone with headband and Cord, 8/6; Headphone Cords, twin, 2/6; 4-way 5 ft. cords, heavy quality 3/-.

CRYSTAL SETS. The Lesdix Bijou Crystal Set in bakelite case, condenser tuning, semi-perm detector and terminals, 15/-.

HAND MAGNETO GENERATORS. Output approx. 70 volts 25 m.a. A.C. perm. Steel Magnet, wound armature driven by gearing in handle, for all experiments, 10/-; 3-magnet type, 12/6; 5-magnet type, 15/-; postage 1/- extra.

MAGNETS. D.C. electro magnets, weight 10 ozs., life on 2 volts 1½ lbs., 4 volts 3 lbs., 6 volts 4 lbs., new surplus, 7/6. The Wonder Midget Magnet AlNi perm.; steel disc, ¾" x ¾" with ⅜" centre hole, 3/6 each. Horseshoe Magnets in several sizes; send for leaflet; "S.L."

VIBRATORS. Mallory, 12 volt 60 m.a., 15/-; special 12 volt transformer, 27/6, delivery ex-stock. Vibrator Contacts, thin H.F. Reed, bakelite mounted, fine thread adjustment, milled locking nut, Government type, 4/-.

TRANSFORMERS. Double wound, 230v to 12 volts 3 amps, 32/6, and 20 volts 2 amps, 30/-.

RELAYS. Send for special leaflet "R.S.L.," we have relays for all purposes. Mercury relay tubes, 5 amp size, 7/6, postage 1/-.

SMALL MOTORS work off 3-8 volt battery or from A.C. mains through transformer, 15/-; transformer, 7/6 extra.

SUPERSEDEERS. H.T. Battery Superseder, D.C./D.C., for Radio Receivers: 6 volt input 110 volts 15 m.a., 12 volts input 230 volts 30 m.a. output, 5¼" x 3¼" x 3¼", model finish, ball bearings, etc., take 1½ amps only from your accumulator, 75/-.

G.P.O. CONNECTION STRIPS, solder tags, telephone type moulded base 60-way, 3/6; 10-way R.A.F. terminal strips, bakelite, 2/9.

BUZZERS. Test Buzzers, double contact blade for distant signals or converting to vibrator, robust construction, ex. G.P.O. stock, 8/6. Morse Practice Buzzer, tunable note, metal case, 7/6; bakelite case testing buzzers, 3/6. The high note tiny Townsend Buzzer for the experimenter, platinum contacts, 10/-



MAHOGANY CANVAS COVERED MARK III CABINETS. 13¼" x 12" x 7¼", with hinged lid and carrying handle, 15/- each. These are exceptionally well made, ½" mahogany; will strip and polish.

All metal cases ex-W.D., as above, 9" x 9" x 8", with hinged lid and loops for carrying handle; with rest for panel; make fine instrument cases, 12/6.

When ordering, please mention the "S.W.M."

ELECTRADIX RADIOS

214 QUEENSTOWN RD., LONDON, S.W.8
 Telephone MACaulay 2159.

EDDYSTONE and the AMATEUR

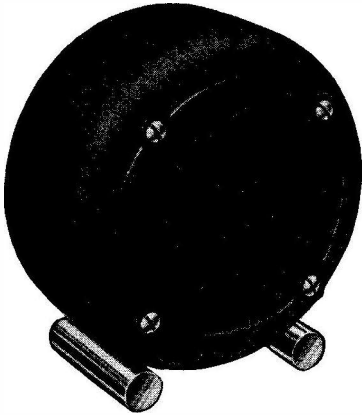

THE EDDYSTONE MINIATURE SPEAKER

for Communications and
Extension Purposes

This efficient Speaker consists of a $3\frac{1}{2}$ " permanent magnet unit mounted in a diecast housing of approximately $5\frac{1}{2}$ " diameter. A special acoustic baffle is fitted which permits maximum performance from the relatively small speaker unit. Especially suitable for use with Communications Receivers, and also as a small extension speaker. Impedance 3 ohms. Complete with lead. Finish ripple grey or ripple black Chromium.

Cat. No. 652

£3.7.6

PLEASE ORDER FROM YOUR EDDYSTONE AGENT
We do not supply direct.



STRATTON & Co., Ltd

EDDYSTONE WORKS - WEST HEATH - BIRMINGHAM, 31



Which Switch is the right Switch?

... is it Rotary or Push-button or Slider? Is it wanted for circuit selection, band selection, tap switching? Is it for a new design or in quantities for a well proved circuit?

Whatever it is — the answer is always OAK!

The basic design of all Oak switches is one of strength and efficient functioning, including such exclusive features as the double-contact clip, and the floating rotor ensuring self-alignment of each section.

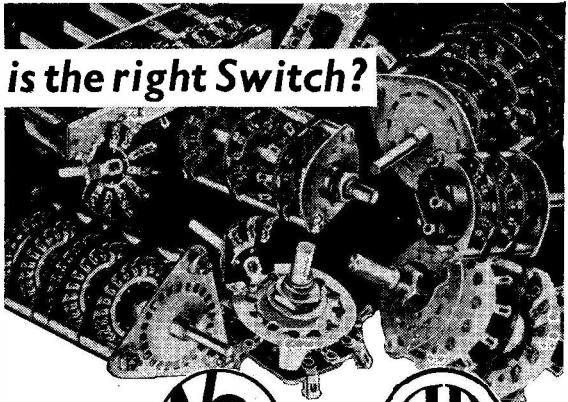

OAK SWITCHES

BRITISH N.S.F. CO. LTD., Keighley, Yorkshire | A.B. METAL PRODUCTS LTD., Feltham, Middx.
(Sole Licensees of OAK Manufacturing Co., Chicago) | (Sub. Licensees of N.S.F.)

The only Manufacturers of Oak Switches under Patent Nos. 478391 & 478392

SERIES 100
**MULTI-RANGE
 TEST SET by
 PULLIN**

A Service Engineers' Universal Testing Set.
 Sensitivity 10,000 Ohms per Volt.

The Instrument is housed in a strong metal case with carrying handle, and is complete with one pair of leads having detachable bull-dog clips and test prods.

Ranges :

AC/DC Volts : 10, 25, 100, 250, 500, 1000. D.C. Milliamps : 2.5, 10, 25, 100, 500. AC/DC Microamps : 100 Microamps on the 10V range. Resistance ranges : 0-1 Meg. (13,500 Ohms mid-scale). 0/10,000 Ohms (135 Ohms mid-scale).

Frequency Range : 15 to 20,000 Cycles per second.

Accuracy : 3% on D.C. Ranges.

4½% on A.C. Ranges (for sinusoidal waveforms).

5% on Resistance Ranges (compensated for normal variation of cell voltage).

Size : 9" x 5½" x 4".

Terminals : Screw plug combination type.

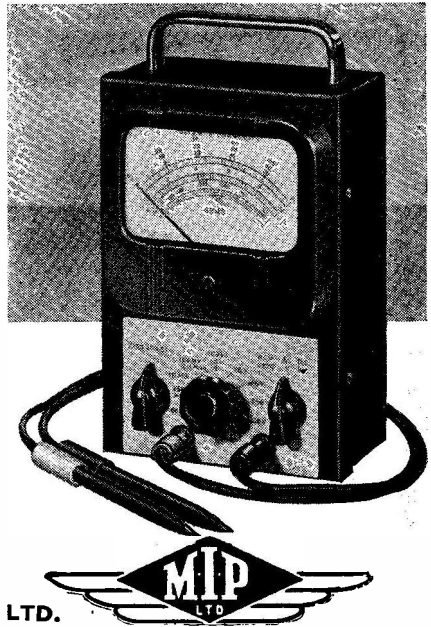

MEASURING INSTRUMENTS (PULLIN) LTD.

Address all correspondence to :

Dept. T, Phoenix Works, Great West Road, Brentford, Middlesex. Telephone : Ealing 0011

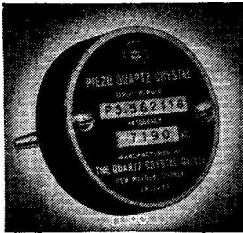

**Q.C.C.
 TYPE P5
 QUARTZ
 CRYSTAL
 UNIT**

This unit uses the well-known Q.C.C. Power type crystal, which is undoubtedly the most rugged and active crystal cut available for amateur use. The crystal is mounted in our type U dust proof holder, with standard ½ in. pin spacing, as illustrated above.

The P5 unit has a temperature co-efficient of 20 cycles per megacycle per degree Centigrade temperature change. Used with a 6V6 or 6L6 type beam tetrode, it will give up to 5 watts r.f. output on the fundamental frequency, and approximately 3 watts on the second harmonic in the Tritet circuit.

Available with fundamental frequencies in the 1-7, 3-5 and 7 Mc. bands for fundamental operation or frequency multiplying to any higher frequency band.

An official certificate of calibration is sent with each P5 unit, giving the frequency under stated operating conditions to an accuracy of 0.025%.

PRICES : Ground to your specified frequency in the above bands ... £1/17/6

Or ground to a frequency not specified by you but taken from our stock ... £1/12/6

Please note that all the leading dealers in amateur equipment now carry stocks of the P5 crystal unit.
THE QUARTZ CRYSTAL CO., LTD. (Directors: E. A. Dedman, G2NH., N. H. R. Munday, G5MA., W. J. Thompson, G2MR.), 63/71 Kingston Road, **NEW MALDEN, SURREY.** Telephone : MALden 0334

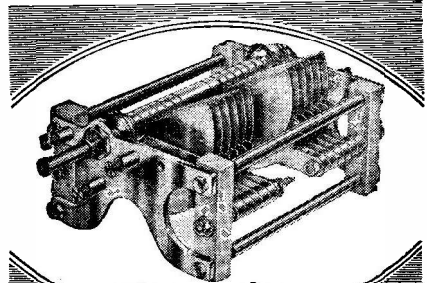

TYPE T.R. SQUARE LAW

"Cyldon"
TRANSMITTING
Capacitors

SYDNEY S. BIRD & SONS, LTD
 CAMBRIDGE (ARTERIAL RD., ENFIELD, MIDDX.)
 Phone : ENfield 2071-2



Queen of Loudspeakers

Main Details of the Range of
CELESTION PERMANENT MAGNET LOUDSPEAKERS

CHASSIS DIAMETER	MODEL	SPEECH COIL IMPEDANCE OHMS	POLE DIAMETER	FLUX DENSITY GAUSS	TOTAL GAP FLUX	PEAK POWER HANDLING CAPACITY
2½"	P2V	3.0	7/16"	8,500	8,000	½W
3½"	P3C	3.0	¾"	7,700	24,000	1W
5"	P5Q	3.0	¾"	8,500	26,000	2W
5"	P5T	3.0		10,500	32,000	2W
6½"	P6Q	3.0	¾"	8,500	26,000	3W
6½"	P6T	3.0		10,500	32,000	3W
8"	P8D	2.3	1"	6,200	24,000	4W
8"	P8M	2.3		8,000	31,000	4W
8"	P8G	2.3		10,000	39,000	4W
10"	P10M	2.3	1"	8,000	31,000	6W
10"	P10G	2.3		10,000	39,000	7W
12"	P14	15.0	1¾"	12,500	140,000	12W
18"	P18	10.0	2½"	13,500	350,000	40W

From the range of Celestion Loudspeakers most manufacturers are able to meet their requirements. The smallest model, a midget weighing 3½ oz. is intended for small personal radios and the largest, capable of handling 40 watts, for public address purposes. Between these extremes, the range is balanced and well considered.

PUBLIC SALES

Several Loudspeakers of this range are available to the public in chassis form or housed in attractive cabinets. All enquiries for these must be directed to our sole wholesale and retail distributors, Cyril French Ltd.

SOLE DISTRIBUTORS
to the Wholesale and Retail Trades:
CYRIL FRENCH LTD.
29 High Street,
Hampton Wick,
Middlesex.
KINGSTON 2240.

CELESTION LTD., KINGSTON-ON-THAMES SURREY · PHONE: KINGSTON 5656-7-8-9

Robert Sharp & Partners

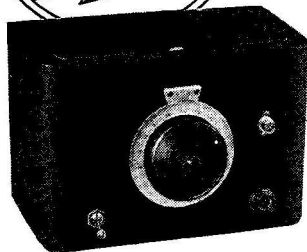
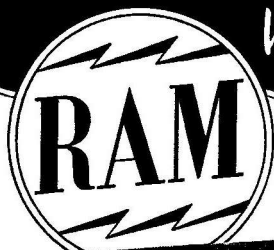

Variable Frequency Oscillator

This equipment provides a stable method of frequency control, with the added advantage that frequency changes can be rapidly and accurately made. The circuit consists of a "Franklin" Oscillator, using two triode valves, with a tetrode valve as buffer stage. An iron-cored tuning unit is used, and is fitted in a cast aluminium screening box. The fundamental frequency coverage is from 3.5 to 4.0 mc/s. A 4" Muirhead Precision S/M dial, with vernier reading to 1/10 of a degree is fitted. The output from the Buffer stage is supplied with a co-axial cable with plug for connection to crystal holder in transmitter. A "stand-by" switch is incorporated. An external power supply is required, and should provide 6.3 volts at 1.5 amps, and 200 to 300 volts D.C. at 18 MA. A separate power pack can be supplied upon request. Write for details of R.A.M. Equipment to Department M.

EQUIPMENT AVAILABLE SHORTLY

Power Pack providing 500 volts at 200 mA, with 6.3 volt heater output. Switched coil assembly for use in Transmitter P.A. circuits. 25 watt Transmitter for three bands. Complete with coils, crystal and power supply.

AGENCIES—We are prepared to consider applications for Agencies in our Radio Products, and invite Traders specialising in Amateur Radio Equipment to communicate with us.

Radiocraft Ltd

11 CHURCH ROAD, UPPER NORWOOD
LONDON, S.E. 19 Phone: LIVingstone 4787

NOTE—We have absolutely no connection with any other firm trading under the same or similar name as ourselves.

TAYLOR 1355

CQ—ALL HAMS

TRANSMITTING VALVES

807	15/-	PT15	£1/5/0
TZ40	£2/0/0	35T	£2/10/0

Above types ex-Govt. **Brand New. Fully Guaranteed.** Other types available at normal list prices.

GOOD STOCKS RECEIVING VALVES.

Transmitting Coils: 56 & 28 mc/s. 4/6. 14 mc/s. 6/-. 7 mc/s. 7/6. Weymouth Coil Packs £1/16/6. Full Range Wearite "P" Coils 3/- each. Ceramic, Amphenol, Paxolin Valveholders for 807, 813, EF50, etc.

Mains Transformers. Porthminster. Fully Shrouded.

350-0-350	80 m/a.	6.3c	3 amp.	5v	2 amp.	
350-0-350	80 m/a.	4v	4 amp.	4v	2.5 amp.	£1/7/6 each

Porthminster Smoothing Chokes. 20 Hy. 500 ohms. 150m/A. 19/-. **Harvey Jones 6 Pin Connectors** 2/- complete. **Cyldon Transmitting Variable Condensers. Wooden Transformers and Chokes. Q.C.C. Crystals. Hamrad Stockists.** We carry good selection TX and RX Gear for Amateur use. Enquiries welcomed.

Mail Order: C.W.O. or C.O.D. £1 and Over.

Carriage payable on all goods under £3 in value. Lists 1d. Pay us a call—it will pay you.

KINGSTON RADIO SERVICE & SUPPLIES
66 London Road, Kingston, Surrey
Phone: KIN 5919

FIT A CRYSTAL FILTER TO YOUR R.II55

We have produced a range designed especially for this receiver, and can supply in matched sets giving bandwidths of 300 ± 50 cps. for C.W. and 3000 ± 100 cps. for 'phone. Frequency response is adjusted to within 1 Kc/s at 560 Kc/s.

Housed in a miniature holder suitable for wiring suspension.

Set of 3 for C.W. and 'phone...	£3/7/6
Set of 2 for C.W. only ...	£2/5/0
Single crystals ...	£1/12/6

All other usual I.F. and oscillator crystals can be supplied.

Delivery from stock

Trade enquiries invited

BROOKES CRYSTALS LTD.

(Est. 1929)

51/53 GREENWICH CHURCH STREET,
LONDON, S.E.10
Gre. 1828

Finest quality B.I.C.C. Enamelled Copper Transmitting Aerial Wire, in 150-foot Coils; 12 s.w.g. 10/3, 14 s.w.g. 6/6. S.C.F. 92 Coaxial Feeder, Polythene insulation, 1/3 per yard, or 100-yard coil for 105/-. B.T.F. 219 Twin Flat Feeder, Polythene Insulation, 6d. per yard, or 250-yard coil for 97/6. "Pyrex" 7-inch Transmitting Aerial Insulators 6/3 each. Please add sufficient to cover packing and postage. Everything mentioned available immediately from stock, despatch same day. Except for clearance junk, there is virtually nothing the "ham" needs which we are unable to deliver immediately. Valves (not "surplus") include 807, 35T, RK34, KT8C, TZ40, DA60, EF50, GU50, 866, U16, U17, U18/20, 5U4G, GT1C, SI30, and countless others, all world-famous brands.

WIRELESS SUPPLIES UNLIMITED

264-266 Old Christchurch Road,
Bournemouth, Hants.

A.C.S. RADIO

WE apologise for any delay in sending out our catalogues due to paper shortage and the very large number of enquiries, but we hope this will be rectified by the time this announcement appears and we shall be pleased to forward our revised list "S.W." of Radio Components and Accessories upon application. Our list of second-hand Communications receivers and equipment is also available.

This month we offer the following items :-

- Muirhead Slow Motion Dials, 3 1/4" diam. engraved 0-180 10/6
- High Voltage Smoothing Condensers, 10 mfd., 1,000v. wkg. 12/6
- Condensers, 4+3 mfd., 400 volt, paper Condensers, metal cased 4/6
- Condensers, 2 mfd., 600 volt, paper Condensers, metal cased 2/6
- Labgear Transmitting Condensers, 75 + 75 mmfd., Split Stator 24/6
- Wearite Miniature I.F. Transformers, 460 kc/s, 1.6 mc/s, 2.1 mc/s, 4.86 mc/s and 9.72 mc/s each 10/6
- Aerovox, 2 mfd., 1,000 volt wkg. Condensers and clamp each 3/-
- Labgear Viewing Units, C.R.O., with power supply and 50 cy. sweep £16 16 0
- Heavy duty 6-way insulated plugs and sockets, panel fitting Per pr. 4/-
- Ditto, 2-way Per pr. 3/-

PLEASE INCLUDE SUFFICIENT FOR POSTAGE

44 WIDMORE RD BROMLEY, KENT

Phone RAVensbourne 0156

NOW READY! Spring Edition of THE RADIO AMATEUR CALL BOOK

300 PAGES

100,000 Call Signs, Names and Addresses

WORLD WIDE

We have pleasure in informing readers of the Short Wave Magazine that the Spring Edition of the "CALL BOOK" is now ready. To comply with import regulations we have arranged with the American Publishers to post copies to subscribers direct from Chicago without delay. Present delivery about 4 weeks.

Supplies are limited. Complete the Order Form and send your remittance to the distributors :

DALE INTERNATIONAL Publications Limited

105 BOLSOVER STREET, LONDON, W.1
Telephone : MUSEum 1023

ORDER FORM
I enclose a remittance for 10/-

NAME.....
ADDRESS.....
.....

10/-
POST PAID
(New U.S. Overseas price \$2.00)

IT COSTS LESS TO USE

*The Finest
Cored Solder in the World*

BECAUSE

YOU AVOID WASTE. The three cores of flux in Ersin Multicore Solder ensure flux continuity, and eliminate solder lengths without flux.

BECAUSE

YOU SAVE TIME. The three core construction of Multicore provides thinner solder walls and gives more rapid melting of the solder, thus speeding up soldering operations.

BECAUSE

YOU ENSURE SOUND JOINTS. Ersin Multicore Solder with correct soldering technique avoids dry or H.R. joints.



MULTICORE SOLDERS LTD.
MELLIER HOUSE, ALBEMARLE STREET,
LONDON, W.1. Tel.: REGent 1411

Catalogue Ref. No.	Alloy Tin/Lead	S.W.G.	Approx. length per carton	List Price per carton (subject)	
				s.	d.
C 16014	60/40	14	55 feet	6	0
C 16018	60/40	18	145 feet	6	9
C 14013	40/60	13	35 feet	4	10
C 14016	40/60	16	80 feet	5	3

Lyons Radio

3 GOLDHAWK ROAD,
SHEPHERDS BUSH, LONDON, W.12
Telephone: Shepherds Bush 1729

Power Transformers

Input—230v. 50 cp/s.
Output—1,200v. (tapped at 700v.) at 250 ma. 4v. at 4 amps., 4v. at 3 amps.
With rectifier valve holders (U.17 for 1,200v. and R21/150 for 700v.) mounted on bracket and wired. All connections are clearly indicated on engraved terminal board.
These transformers are new and unused, fully impregnated and fitted with sturdy mounting brackets. Overall size (excluding valve holder bracket), 9½"×6¼"×8". Packed in wooden crates.

Price 57/6 each (carriage 6/-)

Wavemeters (Ex.-R.A.F.)

Type W1252—Freq. range 22-30 mc/s.
Type W1239—Freq. range 39-51 mc/s.
Apart from the frequency ranges, these wavemeters are of identical pattern.
They are of rectifier type, employing the following valves: 1—VR92 (Diode), 1—6J5, 1—V103 ("Magic-Eye") tuning indicator and 1—6X5G (Rectifier).

The tuning control is fitted with a Muirhead slow motion drive and the components and construction are the best possible quality. For A.C. mains (200-250v.). In copper lined wooden boxes, 15½"×9"×10" deep. Condition as new.
All tested before despatch.
Price (including valves) £3.19.6 (carriage 4/6)

Oscillator Units (Ex.-R.A.F.) Type 145

These oscillator units, which are as new, are a very high stability V.F.O. with switch to change over for crystal operation.
Rotating coils wound on ceramic formers are employed, giving particularly good setting accuracy.
An 807 valve as the osc., four VS150 valves to stabilise the anode and screen voltages, and a filament barretter are included.
A Siemens keying relay is fitted. They are most flexible units suitable for driving many types of transmitters.
Frequency range—2 to 7.5 mc/s.
Price (including 807 and stabiliser valves) 55/- (carriage 7/6)

Worth Noting:—

From the 8th to the 19th April (incl.) we are having a special clearance sale of all the oddments in radio material we have accumulated during the past year. Call early and secure a snip.

UNSURPASSED
for **SHORT WAVE WORK**



Ericsson Supersensitive Telephones simply annihilate distance. Perfect in tone. Really comfortable in wear. British made. All good dealers 30/- or direct

Ericsson

**SUPERSENSITIVE
TELEPHONES.**

22 Lincoln's Inn Fields, London, W.C.1
HOLborn 6936

A NEW TX TO GET YOU THE CONTACTS!

Due to the enormous demand for a transmitter particularly suitable for the new licensee with his maximum wattage of 25, we have designed the 28VX. Being fully conversant with "Ham" requirements we realised that such equipment must be in keeping with present-day operating practice.

Suitable also as an exciter for the Q.R.O. "Ham" we feel the 28VX is what you have been waiting for.

We take pleasure in announcing advance details of the 28VX V.F.O. Exciter/PA.

An efficient compact VFO Exciter/PA unit with an output of 25 watts and with own power supply incorporated. Price £29/10/- complete in chassis form. A brief specification is as follows:—

The 28VX is an Exciter/PA unit incorporating VFO. It has an output of 25 watts. When used as a complete transmitter it is a compact unit, power supply being on the same chassis. The stability is good, and T9 reports have been received on all contacts. Coverage 80 metres, 40 metres, 20 metres. Circuit — VFO — Exciter/PA., valves being 6F6, VFO—807 P.A. Voltage stabilisers are used to ensure the maximum stability, provision for key and modulation also being provided. Link coupling to the aerial is brought out to two terminals. The chassis size is 12" x 10", with an overall height of 10". One set of coils is provided to cover the respective bands.

Delivery—a limited number for immediate delivery against first orders; subsequently 14 to 21 days, although we shall strive all the time to do better than this.

The product is good—the price is very reasonable—post your order NOW.

Yes! we are designing a 150 watt P.A. as an add-on unit for the above. Full details will be advertised when available.

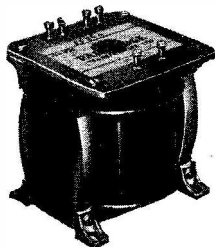

For the past 15 years we have devoted our energies exclusively to the manufacture of Transformers and Chokes. Modern transformer technique is essentially the province of a specialist. Our technical department will be pleased to assist you in your transformer problems. Illustrated above is one of our varied range of styles shown in our catalogue—Free on request.

Telephor.e:

Abbey 2244

PARTRIDGE

TRANSFORMERS LTD

76-8, PETTY FRANCE, LONDON, S.W.1

VALLANCE'S

"where 'Ham meets Ham,'"

144 BRIGGATE, LEEDS, I.

Staff call signs—

G8SX, G2HHV, G3ABD, G3AHV, G3BDD.

Taylor
for the best in test equipment

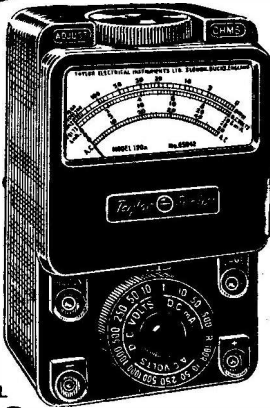

MODEL
120A

Please write for technical brochure to :—

**The Pocket Size
TAYLOR Junior**

This Universal Taylor meter has self-contained ranges up to 5,000 volts D.C. and A.C. at 1,000 ohms per volt and from 1 ma. to 500 ma. D.C. full scale. Resistance ranges with self-contained battery cover from 0.5 ohms to 200,000 ohms and with external battery up to 20 megohms. All voltage resistors and shunts are adjusted to 1 per cent., giving a high degree of accuracy on all ranges. The moving coil meter has a sensitivity of 400 μ a full scale and has a maximum scale length of $2\frac{1}{2}$ ". Weight 14 czs. Size $4\frac{7}{8}$ " \times $3\frac{1}{8}$ " \times $1\frac{1}{8}$ ".

21 Ranges.
1,000 ohms per volt A.C. and D.C.

PRICE **£8. 10. 0**

Now available for immediate delivery

We also manufacture a complete range of Radio Test Equipment including Multirange Instruments, Signal Generators, Valve Testers, Output Meters, Insulation Testers, Circuit Analysers, Oscilloscopes, A.C. Measuring Bridges and Ohmmeters; also Moving Coil Instruments with scale lengths from 2" to 5".

Taylor Electrical Instruments Ltd.

419-424 MONTRÖSE AVENUE, SLOUGH, BUCKS.
Tel: SLOUGH 21381 (4 lines) Grams: TAYLINS, SLOUGH

<p>Approved</p> <p>Before appointment each Denco Stockist has given evidence of possessing the right technical qualifications to give you good service in connection with our products.</p>	<p>LOOK FOR THIS SIGN IN YOUR DISTRICT</p> <div data-bbox="466 917 601 1021" style="text-align: center;"> </div> <p>APPROVED STOCKISTS</p>	<p>Stockist</p> <p>This word is chosen advisedly. Our aim is that you should be able to obtain what you want ex-stock from the range carried by our stockists. First list below :—</p>
<p>BATH L. F. Hanney</p> <p>BOSTON Vample Bros.</p> <p>BRADFORD J. Dobson</p> <p>BRIGHTON Goodsell, Ltd.</p> <p>BRISTOL Cranbrook Radio</p> <p>CAMBRIDGE Baily, Grundy, & B.</p> <p>CHADWELL HEATH Drury, Beardow</p> <p>CONWAY J. W. B. Evans</p> <p>CORNWALL St. Columb Radio</p> <p>COVENTRY L. & K. George</p>	<p>DARLINGTON C.R.S.S.</p> <p>ELGIN Sam Murphy</p> <p>FOREST HILL, S.E.23 E. A. Porritt</p> <p>GILLINGHAM Radiovision</p> <p>GLASGOW Radiographic</p> <p>HARROW Odeon Radio</p> <p>HASTINGS (Ore) Service Radio</p> <p>HIGH WYCOMBE Ryan Bros.</p> <p>KINGSTON Kingston Radio S. & S.</p> <p>LEEDS Vallance & Davison</p> <p>LONDON Well-known firms</p>	<p>LOWESTOFT N. J. Brundle</p> <p>NEWCASTLE N. F. Whatley</p> <p>NORHAM-ON-TWEED O. C. Doley</p> <p>NOTTINGHAM University Radio</p> <p>ORMSKIRK Coulphone Radio</p> <p>RUGBY Benn Radio & Elec.</p> <p>SALISBURY Southern Radio</p> <p>SOUTHAMPTON Worboys & Tourtel</p> <p>SWINDON K. L. W. Cook</p> <p>TEIGNMOUTH South Devon A.S.</p> <p>WORTHING Bowers & Wilkins</p>
<p>DENCO (CLACTON) LTD., OLD ROAD, CLACTON, ESSEX</p>		

A NEW ADVENTURE FOR

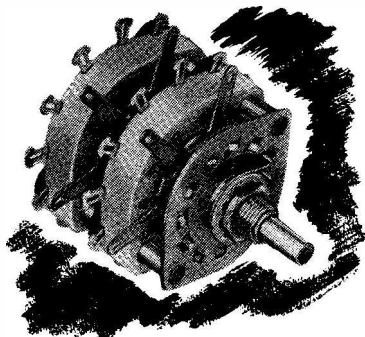
Hams

YOU CAN NOW GET CERAMIC SWITCHES IN A NUMBER OF USEFUL COMBINATIONS FROM YOUR DEALER

Wearite Ceramic Switches, hitherto restricted to Government and other priority uses, are now released. See your dealer and have your Ceramic Switches built to your specification from his kit of Wearite Switch Components. The finished job will be robust, trouble-free, and backed by the famous Wright & Weaire reputation. If any difficulty is encountered, please contact us.



CERAMIC SWITCHES

See your dealer today

NOW AVAILABLE FROM

Premier Radio	LONDON
Webb's Radio	LONDON
Brighton Trades Services	BRIGHTON
Amateur Radio	BURNLEY
Clydesdale Supply Company	GLASGOW
F. J. Ansell	IPSWICH
Jack Bryant	NORFOLK
Southern Radio	SALISBURY
Fenwick's Radio Stores	WOLVERHAMPTON

WRIGHT & WEAIRE LTD. GT. PETER HOUSE, 2 LORD NORTH ST., WESTMINSTER, LONDON, S.W.1 and SIMONSIDE WORKS, SOUTH SHIELDS, CO. DURHAM.

CLYDESDALE *The Radioman's Shop*

for *BARGAINS* in
BRAND NEW
EX R.A.F./R.N.
RADIO EQUIPMENT
SEND NOW for Latest Lists

RECEIVERS
 AMPLIFIERS
 LOUD HAILERS
 POWER PACKS
 13 VALVE I.F.F. UNITS
 S.W. COIL TURRETS
 MOVING COIL HEADPHONES
 MICROPHONES
 MICRODENSERS
 MILLIAMMETERS
 VOLTMETERS
 Etc., Etc. *At remarkably Low Prices*

CIRCUITS AVAILABLE

MCRI RECEIVER CIRCUIT
 Plus Circuits of suitable AC/DC Mains Units, etc.
 Our Price only 2/9 per set. Post free.

R.1155 RECEIVER CIRCUIT
 With parts list at 1/3 each. Post free.

Your enquiries welcomed. We are at your service

CLYDESDALE SUPPLY CO., LTD., 2 Bridge Street, GLASGOW, C.5
 Phone: South 2706/9 and Branches in Scotland, North England and Northern Ireland

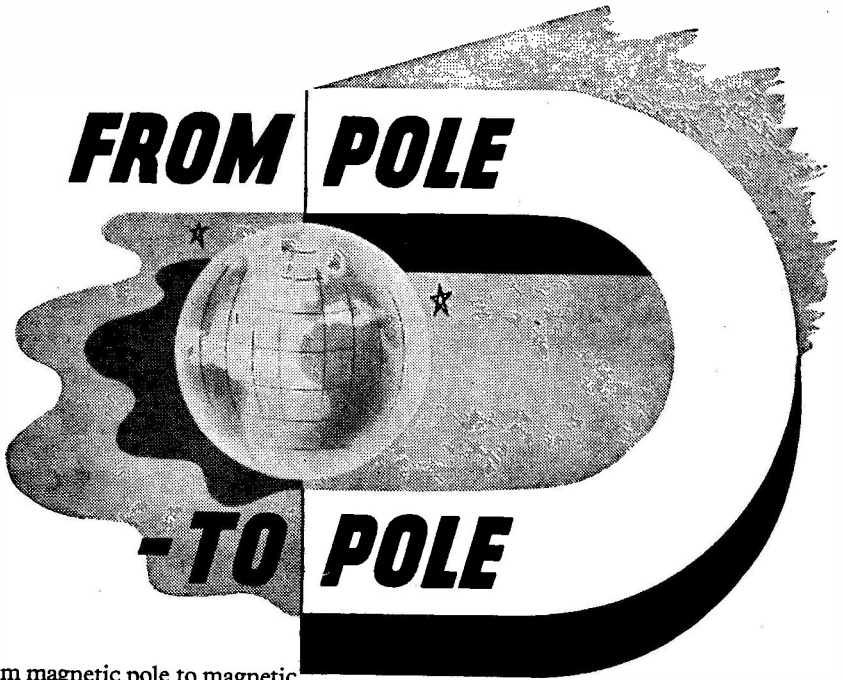

From magnetic pole to magnetic pole, wherever magnetic circuits have to be designed with high efficiency, more and more manufacturers are specifying ★“Ticonal” permanent magnets.

★ Mullard “Ticonal” magnets are anisotropic, i.e., they possess greatly increased properties along the preferred axis. They were the first anisotropic magnets commercially available; they are still the best

“TICONAL”

(REGD. TRADE MARK)

PERMANENT MAGNETS MADE BY MULLARD

THE MULLARD WIRELESS SERVICE CO. LTD., CENTURY HOUSE, SHAFTESBURY AVE., LONDON, W.C.2. (8)

SHORT WAVE MAGAZINE

FOR THE RADIO AMATEUR AND AMATEUR RADIO

Vol. V

APRIL 1947

No. 45

C O N T E N T S

	<i>Page</i>		<i>Page</i>
Editorial	79	Worked All Zones.....	100
Anode Follower for Audio Gain <i>by R. Knowles, B.A. (G3AAT)</i> <i>Instr. Lieut., R.N.</i>	80	Calls Heard	102
EF50 as Crystal Oscillator <i>by J. Hum (G5UM)</i>	84	First Class Operators' Club.....	103
Concrete Evidence <i>by N. P. Spooner (G2NS)</i>	87	Five Metres <i>by A. J. Devon</i>	104
One Watt Can Still Work Wonders! <i>by W. Oliver (G3XT)</i>	90	5-10 Converter for R.1155 <i>by G. Elliott, B.Sc., A.R.I.C.</i> ...107	
Simplified Coverage Calculations <i>by K. E. Marcus</i>	91	Off the Air <i>by The Old Timer</i>	112
Keying and Metering System <i>by A. G. Sutton (G3ADH)</i>	92	Adding Mains Voltage <i>by J. Ostle (G2DYV)</i>	115
DX Commentary		Here and There.....	116
On the Amateur Bands <i>by L. H. Thomas, M.B.E. (G6QB)</i>	94	ABCC.....	117
		New QTH's	118
		Other Man's Station, ZB1AB.....	119

Editor : AUSTIN FORSYTH, O.B.E. (G6FO). Advertisement Manager : P. H. FALKNER
Assistant Editor : L. H. THOMAS, M.B.E. (G6QB).

Published on the first Wednesday in each month at 49 Victoria Street, London, S.W.1
Telephone : Abbey 2384. Annual Subscription : Inland 20s. Abroad 22s. post paid.

AUTHORS' MSS.

Articles submitted for editorial consideration must be typed double-spaced with wide margins, on one side only of quarto sheets, with diagrams shown separately. Photographs should be clearly identified on the back. Payment is made for all material used, and a figure quoted in the letter of acceptance. A large stamped addressed envelope should be enclosed for the return of MSS. not found suitable for publication.

THE SHORT WAVE LISTENER ASSOCIATED WITH THIS
MAGAZINE IS SPECIALLY FOR THE RECEIVING ENTHUSIAST

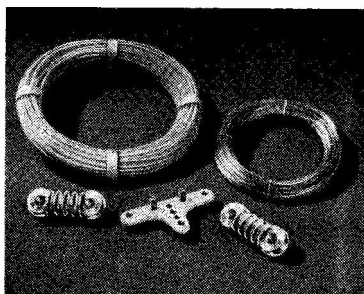

THE IDEAL AERIAL FOR THE AMATEUR

This very practical kit consists of a "T" strain insulator, 80 ft. of cadmium copper wire and 80 ft. of L336 balanced twin feeder with plug and socket to suit (see illustration below) and two glass end insulators. The "T" insulator in the illustration has been designed to take the feed from the centre of a half-wave di-pole. Sensible terminals and "cable grips" are provided.

For receiving purposes, the length per half-section is not critical to within a few inches, but for transmission the lengths given are approximate only and must be slightly re-adjusted to the correct length from the formula:—

$$\text{Length of half-section in feet} = \frac{234}{\text{Frequency in Mc/s.}}$$

Cadmium copper is supplied as this will not stretch—a most important matter if the aerial is being used for transmission.

The complete kit with instructions in carton, L609.

Short Wave Amateur Band		Short Wave Broadcast Band	
Frequency in Mc/s	Length in feet	Frequency in Mc/s	Length in feet
7.0	32.75	6.0	40
14.0	16.5	9.0	27
28.0	8.0	12.0	20
56.0	4.25	15.0	16
		18.0	13
		21.0	11

Length given is per half-section.

BELLING & LEE LTD
CAMBRIDGE ARTERIAL ROAD, ENFIELD, MIDDX

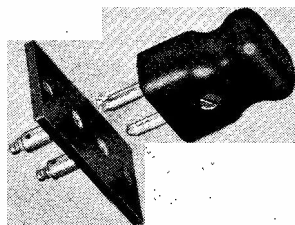

Made by **ROTHERMEL** ... that means
QUALITY, PERFORMANCE & RELIABILITY

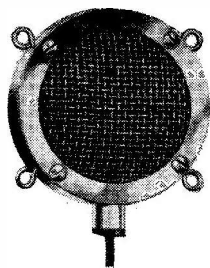

ROTHERMEL TYPE D.104 PIEZO ELECTRIC CRYSTAL MICROPHONE

This model is eminently suitable for short-wave work. It is inexpensive, and provides an output level slightly higher than a condenser microphone and 3 D.B. lower than a carbon microphone, whilst in all other respects such as performance, reliability, quality and ruggedness of construction, the D.104 is pre-eminent.

The dimensions are 3" diameter x 1" deep. The D.104 is finished in chromium and is furnished with 6 feet of high quality shielded cable together with either four screw eyes for suspending in a ring, or with handle, with or without built-in switch key, which short-circuits the microphone when not in use. The output level is approximately minus 60 D.B. Price £5-5-0

TYPES 'A' AND 'B' CRYSTAL HEADPHONES

Types 'A' and 'B' headphones for many years for their light weight, sturdiness and wide frequency response range.

Type 'A' is a light-weight general-purpose headphone, while Type 'B' is ultra-light, weighing less than 3½ ounces including headband and cord, and is hermetically sealed.

The impedance of Type 'A' is over 50,000 ohms at 400 cycles while Type 'B' is 25,000 ohms at 400 cycles.

Price: Types 'A' or 'B' complete with cords and headbands £3-10-0 per pair

Send for literature giving full technical details of all ROTHERMEL Piezo Electric Crystal Products and other Equipment

R. A. ROTHERMEL LTD.,

Rothermel House, Canterbury Road, Kilburn, London, N.W.6
Telephone: MAIDA VALE 6066 Telegrams: Rothermel, London



EDITORIAL

Equipment

A visit to the recent R.C.M.F. Exhibition—organised on a more ambitious scale than last year—was at once exhilarating and depressing.

Exhilarating because again there was abundant evidence of the quality of their products and the ingenuity and resource of our radio component manufacturers in meeting and anticipating requirements in the technical sense.

One was depressed by quite different influences. At practically every stand, delivery dates for the home market were quoted in terms of months, if not years. Nearly all exhibitors explained this as being due to current industrial difficulties. The interlocking and interdependence of the radio and electrical industries, with all their many ancillaries, is now so vast and complex that a new shortage in an unexpected direction frequently has far-reaching and long-term repercussions.

From the Amateur Radio point of view, all this must mean that for a considerable time to come we shall in effect be dependent mainly upon war surplus apparatus for equipment and components. Fortunately, as it now turns out, there are very large stocks of such material available, most of it of the highest quality, but not all suitable for amateur work without considerable modification.

While it is also a depressing thought that there are only a small number of manufacturers who are operating with the immediate intention of developing the Amateur Radio market, this certainly does not mean that we shall be brought to a standstill for lack of equipment.

And when the country pulls out of its present difficulties, we can expect to see some of the finest radio apparatus in the world offered to the British amateur.

Austin Forster G6FO.

Anode Follower For Audio Gain

Theory and Design of Practical Circuits

By R. KNOWLES, B.A. (G3AAT)
Instr. Lieut., R.N.

The anode follower arrangement for AF working has not yet obtained in Amateur Radio circles the recognition which is its due. The circuitry is simple and high gain with distortionless output can be achieved.—Ed.

WHEN compared with RF amplification, at first sight AF amplification might appear to present few difficulties. That this is not really the case can easily be verified by a few moments' listening on the 'phone bands. One of the major differences between AF and RF amplification is that the shape of the wave must be preserved in the audio case, but on the RF side the output wave may bear little resemblance to that of the oscillator.

One of the most elementary ways of getting audio gain is to use a triode with a resistive anode load and battery bias. This works quite well, but like most simple circuits it has its snags. The output waveform is dependent on the valve characteristics, and unless the optimum values for the circuit parameters are known, more distortion of wave shape than is absolutely necessary will occur. The manufacturer can give us the values for one set of conditions, but as frequently happens these conditions are not those under which valve is required to be used. Rather laborious and quite complicated mathematical reasoning could give us the optimum values to suit our conditions, but there is a way out of this dilemma now that high gain valves are plentiful. Introducing a new technique for AF amplification is the function of this article, but first let us consider some of the pitfalls that it enables us to avoid.

A form of distortion frequently encountered in normal stages is failure to amplify all required frequencies uniformly, termed frequency distortion. Owing to the high input capacity of the triode valve, this otherwise very good type is rather prone to frequency distortion. A pentode on the other

hand suffers from markedly curved characteristics and a high internal impedance, which in this case is unhelpful, though it is going to be turned to good account shortly.

The Anode Follower

If the curvature of the valve characteristics is the only factor which is going to prevent us from using this very useful valve, it will be worth trying to find some way of minimising this defect. It is generally appreciated that negative feedback does reduce distortion as well as reducing the gain. The circuits about to be described are only special cases of a negative feedback amplifier.

In the circuit of Fig. 1 there are one or two things which must primarily be assumed and then explained satisfactorily later. The first is rather alarming and it is that the mutual conductance of the valve is extremely large—so large, in fact, that the Ia-Vg curve boils down to an almost vertical straight line at $V_g=0$ and the valve therefore has no grid base! Another way of contemplating this state of affairs is to think that the range of grid volts is so small that the valve may pass any anode current within reason for $V_g=0$. The second assumption is not nearly so outrageous; it is to assume that the internal impedance is so high that it does not shunt the output at all.

Take these two statements on trust for the moment; the working of the circuits using this imaginary valve will be explained, and it will be shown that a high slope pentode does not differ so greatly from this ideal valve.

We have the condition that the grid

voltage, V_g , must at all times be made to be 0, this being true for any value to anode current that the valve can turn on. If now a voltage, V , is applied of the input end of R_1 , a current equal to $\frac{V}{R_1}$ must flow down it as the grid end is at zero potential, and for this to be so all this current must flow up R_2 to the anode. That is to say, $\frac{V_a}{R_2} = \frac{V}{R_1}$ or V_a is $\frac{R_2}{R_1}$ times the original voltage V . This is the gain of the stage and is dependent only on two resistances, whose values will stay constant over the whole audio spectrum.

Suppose now that the valve of infinite gain is replaced by an EF50 type, which should be a little easier to obtain in these hard days! The grid base is of the order of 5 volts, with 250 volts on the anode and screen. The internal impedance is of the order of 1 megohm, and when it turns on 10 mA (the maximum anode current officially allowed) the minimum anode voltage is about 30 volts. To fix these conditions an anode load of 22,000 ohms (preferred value) is suitable for use with an HT supply of 250 volts.

Thus, when the valve is cut off the anode voltage is 250 and when it is bottomed (this happens at $V_g=0$) the anode voltage will be 30 volts, as at 10mA the 22,000 ohm resistor drops 220 volts. The peak-to-peak voltage that the valve could handle is therefore 220 volts, but we usually allow 10 volts margin at each limit. The middle of this range is 140 volts, and sufficient grid bias must be supplied to make the valve "sit" at this voltage, as we are dealing with a practical valve and not one without any grid base. If a 140 volt negative line were available, then a grid leak whose value was the same as R_2 and which was taken to the negative line would make the anode sit very near this potential. By altering the ratio of the grid leak to R_2 we could use a negative line not at -140, but at nearly any value below, say, -50 volts. Note that the exact grid voltage for the anode voltage to be

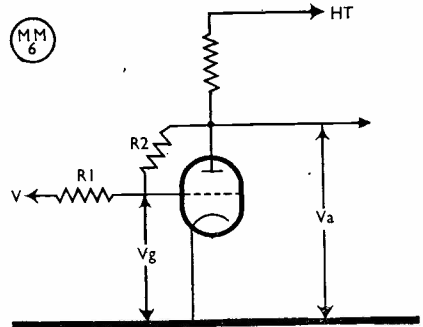

Fig. 1. The basic circuit.

140 is not known and, anyway, is small. The circuit settles down to give the required grid bias, provided that the mutual conductance of the valve is high enough.

If an alternating voltage is applied to the input of Fig. 2, which shows a complete circuit, then an alternating voltage magnified by the ratio $\frac{R_2}{R_1}$ will

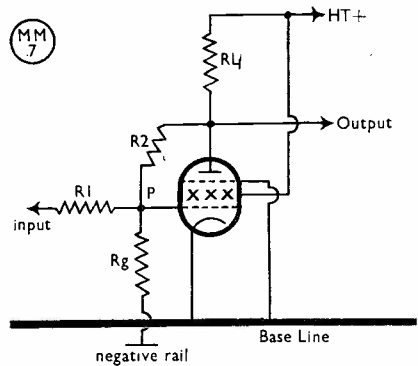

Fig. 2. Complete circuit, values for which are given below.

Table of Values

Anode Follower AF Amplifier

R1	=	180,000 ohms
R2	=	1.8 megohms
Rg	=	2 megohms
RL	=	22,000 ohms
HT line	=	250 volts
Negative rail	=	-150 volts
Valve	=	EF-50

have to exist at the anode for the circuit to remain in equilibrium. The above ratio must not be so great that the anode voltage would have to swing outside the limits already stated, or the circuit will cease to work as we have reasoned and distortion will occur.

There is no reason why the input should not go directly to the anode of a previous stage, provided that the leak to the negative line is suitably reduced to allow for the DC potential on the anode of this previous valve. So far nothing has been said about the actual values of these resistors, only their ratios have been mentioned. It is a little unfortunate that the reasoning breaks down if a gain of more than about twenty times ($\frac{R_2}{R_1} = 20$) is attempted; of course, the stage still works, but there will be no guarantee of freedom from distortion, especially in view of the low value of anode load proposed. Also, it is not advisable to use resistors above 2 megohms as they are liable to wander in value when it is damp, and with high values the effects of stray capacities cause the impedance of the resistor to vary with frequency, the one thing that we do not want to happen.

The choice of resistors is therefore governed by their ratios, and the fact that while a high value all round is desirable, no one resistor must be greater than 2 megohms. Having decided on the gain, the grid leak must be calculated from the fact that the total current flowing into the point P in Fig. 2 must equal the total current flowing away from it. With the EF50 type valve it can be assumed that the point P will be at earth potential when the correct value of grid leak is chosen.

All the values for a voltage amplifier giving a gain of ten times, using an EF50 and having a -150 line from which to get the grid bias, are given in the table accompanying Fig. 2.

Use of Cathode Bias

What can be done if there is no negative line, or if only a few un-

stabilised volts are available (if negative volts are small, the grid leak must be small and a loss of gain may occur for which the feedback cannot compensate)?

It is quite in order to use cathode bias, but some blocking condensers must be added, and unless precautions are taken, these blocking condensers will cause frequency distortion. The precautions against this are simple; make the time constants of both arms equal. In Fig. 3, $C_1.R_1 = C_2.R_2$ and the values of C_1 and C_2 could be 1 and $0.1 \mu F$ respectively. In order to make the anode sit at 140 volts (condition for maximum output) the bias resistor must be adjusted. If a small output is required the anode sit point can be lower than 140 volts with the advantage that the mutual conductance of the valve will be greater with the larger value of anode current which would flow under these conditions. As long as the anode voltage is not required to drop below, say, 40 volts (30 volts plus 10 volts margin), amplitude distortion will not occur and a higher gain may be demanded when only a small output is wanted.

To measure the voltage at which the anode is sitting a high resistance meter (20,000 ohms per volt) ought to be used when cathode biasing is employed, but with the critical grid leak method an inferior instrument will be satisfactory.

Power Amplification

The circuit of Fig. 3 is also suitable for power amplification, provided that the valve is a high slope output pentode or beam tetrode. It is essential to use cathode bias when the anode has a low DC resistance, as the self-regulating grid bias feature of Fig. 2 is absent. The choice of bias resistor is that value which will make the valve draw its maximum permitted standing anode current and will not differ widely from the manufacturer's recommended value for normal operation. The optimum load is nearly equal to the anode voltage divided by the standing anode current. This value is a first approximation only, but owing to the feedback

it is not very critical. A gain of between one and five times is advised and, in general, the lower the gain that is demanded from the output anode follower the smaller will be the distortion. Since almost distortionless amplification is easily obtained by further anode followers, a low power stage gain can be afforded.

The actual output impedance of the stage is approximately $\frac{G+1}{gm}$ where

G is the demanded gain and gm is the mutual conductance of the valve. This output impedance is lower than the optimum load and so the valve damps the resonance of any circuit in its anode. This is advantageous when feeding a loudspeaker, but when the load is a modulated RF stage the only effect is to make the ratio of the modulation transformer less critical.

There is one serious snag to the use of the circuit as it stands, and that is that any hum in the HT supply is magnified by the feedback action. This only occurs with transformer coupling and can be avoided by taking the feedback from the secondary of the output transformer, making due allowance for its ratio when calculating the values of the resistances and being careful to wire it up so that negative feedback is obtained.

Types AL60, EL6 and DDR2 are the valves expressly recommended for this service, though the author has used 6L6 and 6V6 with a fair degree of success. With the first three types

it is practical to demand a voltage gain of 10 times without encountering any trouble, for these valves have exceptionally high values of mutual conductance.

Conclusion

The anode follower is a simplified case of negative voltage feedback and not really anything radically different, but it is not widely known or used in amateur circles. Now that high slope pentodes are available in large numbers from various sources there are not really any objections to its use. Although a gain of about twenty times is the most that ought to be demanded, many stages can be connected in cascade without instability because the effect of HT variation is countered by the feedback action. Stray capacity and valve capacity set an upper limit to the frequency response at about 100 kc with average circuits. This can be extended by a simple neutralising arrangement, and the circuit is then able to handle short pulses without phase distortion. The lower limit of frequency response is zero for the critical grid leak case, and for the cathode bias case is set by the condensers.

The circuit is very easy to set up and get going, as an exact knowledge of valve characteristics is not necessary. The grid must have a stopper of about 1,000 ohms right at the pin to act as a parasitic suppressor, and in some cases screen or anode stopper of 50 ohms may be needed. It is easier to fit stoppers first than to try and locate the cause of parasitics after an amplifier is finished. All high slope valves are prone to parasitic oscillation.

Owing to the feedback, microphony will not be troublesome and the author has used the circuit in aircraft without the usual microphony troubles. The circuit can be confidently recommended for portable operation for this reason.

*To ensure your copy,
become a Direct Subscriber*

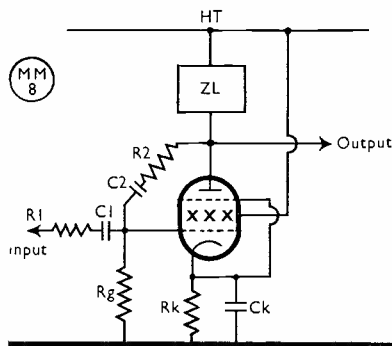

Fig. 3. Anode follower using cathode bias.

EF50 as Crystal Oscillator

New Application of a Versatile Valve

By J. HUM (G5UM)

Judging from the enthusiasm aroused by a recent straight receiver design specifying the Mullard EF50 valve (*Short Wave Magazine*, August, 1946*), the writer believes that many experimenters would be interested in the possibilities of this valve for low-power transmission as well as for reception. Accordingly, he has recently conducted a number of tests to examine those possibilities.

It must be confessed that he embarked on this investigation with a certain amount of misgiving. For the EF50 is by its electrical characteristics a comparatively small valve that hardly looks like the type to stand the heavy punishment so often administered to valves in amateur-built transmitters, where maximum output is required for minimum expenditure on power supplies. Nor were one's misgivings allayed by the fact that in the few instances where the EF50 was specified as an oscillator in wartime Service equipment, it was always treated (electrically) rather gently and its output generally boasted a good deal before being applied.

All of which is, of course, perfectly logical, since the valve is after all a receiving RF pentode with a very high impedance, not at all like the medium-impedance valves commonly used in transmitters.

Triode Connection

A cautious approach to the problem therefore seemed indicated. The writer decided that the best line of attack was not to treat the valve as a pentode at all, but to try it out as a triode-connected crystal oscillator. Triode connection, it will be remembered, is the form in which the EF50 was used in the detector stage of the "All EF50 TRF Receiver," where it functioned very smoothly and sweetly. When triode connected it can be said to approximate very broadly to the well-known 6J5 valve.

In Fig. 1 is shown the circuit which was first employed. As will be seen, suppressor, screen grid and anode are strapped together and connected as one anode. The cathode is tied down to base-line. The inductance L for the 3.5 mc band con-

sisted of 38 turns of 18 SWG enamelled wire on a standard 1½-in. former, tuned by a 75 μF variable condenser. The RF chokes were Bulgin base-mounting short-wave types. The grid return resistor was deliberately selected to have the rather high value of 250,000 ohms with a view to increasing the possible second harmonic output of the oscillator. Condenser C2 is the usual mica by-pass type of any value between .001 and .01 μF . The crystal selected for the test had a fundamental frequency of 3,580 kc.

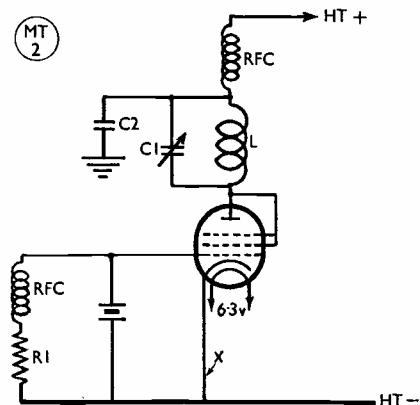

Fig. 1. Triode connected EF50, as tested by G5UM. This only worked satisfactorily when a 700-ohm bias resistor and by-pass condenser were connected at point X.

It was decided not to mollycoddle the EF50 but to give it the full 400 volts from the power pack normally employed for 6V6 and 6L6 crystal oscillators in other equipment at G5UM. At this voltage the standing anode current in the EF50 was 46 mA. Under conditions of oscillation the anode current dropped to 8 mA. An artificial aerial was loosely coupled to the anode coil, which caused an increase in anode current to anything up to 25 mA according to the degree of coupling. However, to standardise all the subsequent tests it was decided to measure the RF output of the EF50 crystal oscillator at the minimum dip position. At 8 mA, then, it was observed that an

* (Now out of print, but still in demand.—Ed.)

RF current of 0.23 amps was flowing in the artificial aerial.

To make the tests really complete the suppressor grid was next disconnected from the anode and left free. No difference in operating conditions was apparent. The suppressor was then connected to earth. The only difference detectable was that the non-oscillating standing current dropped to 42 mA, but the oscillating current was still 8 mA.

However, one undesirable characteristic of the circuit as shown was that oscillation was not at all "smooth and sweet"—to quote our earlier phrase. Indeed, the crystal did not oscillate unfaithfully and at the same position of the condenser each time. Most amateurs will have encountered this condition in their experiments with crystal oscillators, and will know that the remedy for it is to apply a little cathode bias. This was duly done with the circuit of Fig. 1, and at point X on the cathode return a 700-ohm resistor was inserted, paralleled by a 300 μF fixed mica condenser.

At once, oscillation stopped and started as easily as one could wish. And, as was to be expected, considerable changes occurred in the anode current readings. Standing current was now only 8 mA and when the valve oscillated it dropped to 5 mA—*yet the same 0.23 amps still flowed in the artificial aerial.* Could there be a more effective demonstration of the importance of cathode bias in a crystal oscillator?

Pentode Connection

The next step was to try out the valve in its "natural state," that is, as a pentode. The screen-grid was disconnected from anode and fed via a 25,000-ohm resistor, plus the usual by-pass condenser to earth. To begin with, the suppressor was left free, unconnected either to anode or earth. No cathode bias resistor was employed.

In this state the standing anode current was 30 mA, *but no oscillation could be produced at all.* On restoring the cathode bias resistor and condenser oscillation occurred once more, standing current being 12 mA and oscillating current 8 mA. Barely 0.2 amps of RF could be obtained in the artificial aerial.

Not a very encouraging start for pentode operation. But the suppressor grid G3 is still disconnected. The next thing to do is obviously to earth it. When this was done under these pentode conditions, a most remarkable improvement in performance resulted. The standing

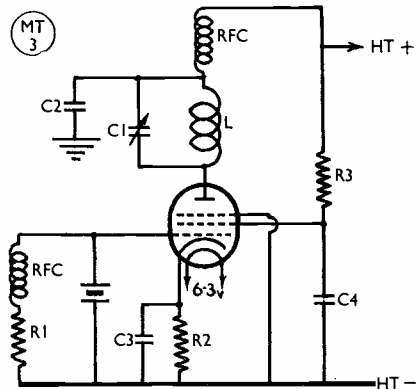

Fig. 2. The circuit modified to give the best output and stability.

Table of Values

EF50 CO

C1	75 μF .
C2	0.001-0.01 μF , mica.
C3	300 μF .
C4	0.001-0.01 μF , mica.
R1	250,000 ohms.
R2	700 ohms.
R3	25,000 ohms.

Note : Values refer to Figs. 1 and 2.

current became 7 mA, the oscillating current 9 mA, *and the RF current in the artificial aerial rose to 0.35 amps!*

Obviously, this was the condition in which the EF50 should be used as a crystal oscillator, and its performance as such far exceeded the writer's anticipations at the beginning of the experiments. The final circuit is shown in Fig. 2.

As a matter of interest, the suppressor was connected to cathode instead of earth, with a slight drop in output—though there was little difference, at least when the 700-ohm bias resistor was used.

As a further test a 6V6G was tried out in the same circuit and with the same artificial aerial. It gave 0.38 amps of RF—but at an anode consumption of 25 mA under the same loading.

This encouraged the conclusion that the EF50 crystal oscillator can be used wherever the more common 6V6G is employed, with little drop in output but at a tremendous saving in input.

Further Tests

Two other points which the experimenter may query are : Where to key? and How about higher frequencies?

The answer to the first point is : Key

in either the cathode or the screen lead. The writer prefers to key a CO in the cathode, because some valves continue to oscillate even when the screen circuit is broken—and that is not very helpful when one wants to work break-in. Cathode keying of the EF50 breaks very little current, and gives a clean and positive make-and-break.

On the subject of using the EF50 crystal oscillator on higher frequencies, the writer considered it important to ascertain how it would function there, since more amateurs will want to use it at 7 mc rather than at the frequency of 3.5 mc on which the above tests were conducted. Therefore, an 18-turn anode coil was used with a 7 mc crystal—and the performance of the oscillator was duplicated exactly, even to the amount of RF energy it fed into the artificial aerial. How it would perform with a 20-metre crystal the writer has no means of telling, but since the EF50 has a higher slope and lower internal capacity than the conventional CO pentode, he would hazard a guess that it will function better than most at 14 mc.

Final Points

Those who have encountered the EF50 crystal oscillator in its wartime applications may ask why no regeneration capacity is shown in Fig. 1. This is a very reasonable question; for the EF50, having a very low self-capacity, has been known to be "hard to start" without a small condenser of about $5\mu\text{F}$ connected between anode and grid, to provide the necessary feed-back.

No such condenser was found necessary in this series of experiments. Perhaps that was because sufficient stray capacity existed between the wiring connections to provide the same effect. Anyhow, it is a point worth bearing in mind by those who cannot make the EF50 oscillate first time in the circuit shown at Fig. 2.

Another query that may be anticipated is whether in fact the valve was not being over-run in the above tests, and the answer to that one is: Yes, it was—grossly! Its metal envelope became too hot to touch—and would no doubt have blushed with shame at such treatment if it could have become any redder than its normal rubicund self. This treatment was intentional; indeed, the valve was left in oscillation for a space of two hours yet showed no signs of grid emission. At more normal voltages it will jog along even more comfortably and should last a considerable time. Certainly at 300 volts

it could be safely loaded up to 20 or 30 mA anode current, to provide a very nice single valve transmitter for low-power CW work on the crystal fundamental frequency.

Of its uses in other transmitter applications one can say that as a general principle a valve that works well as a CO will work well as a doubler, and Fig. 3 shows the diagram of a circuit that will not merely double but which gives an appreciable amount of fourth harmonic as well. By the same token, there is no reason why the EF50 crystal oscillator should not give two-band working by itself by the simple expedient of connecting it as a tri-tet in the usual way.

Finally, a mild disclaimer—the writer's enthusiastic advocacy of the EF50 may lead some readers to suppose complicity between himself and the makers. He must therefore emphasise that his opinions are his own and that so far from being connected with Messrs. Mullard he has never been near them in his life.

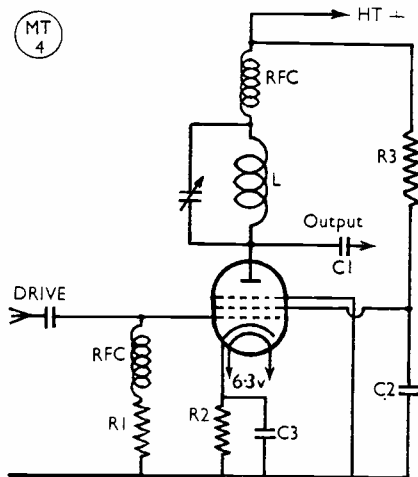

Fig. 3. A suitable frequency-multiplier circuit using the EF50.

Table of Values

EF50 as Doubler

R1	100,000 ohms.
R2	1,000 ohms.
R3	100,000 ohms.
C1	100 μF .
C2	.0005 μF .
C3	.0003 μF .

Concrete Evidence

Mounting, Dressing and Raising an Aerial Mast

By N. P. SPOONER (G2NS)

Gone are the days when with or without the inducement of a prolonged visit to the "local" a neighbouring builder's foreman could be persuaded to conjure up forty feet of scaffold-pole. Gone also are the days when a Post Office lorry laden with disused telephone posts could be attracted to one's garden gate. Even the liberation nowadays of a railway-sleeper for use as a tabernacle calls for complicated operations of a combined nature. And as most amateurs have discovered when planning a new aerial system, chimney-stacks never seem to grow in quite the required positions.

When, therefore, in this era of muted merriment a really good aerial mast is acquired, it should certainly be cherished. The sky-wire is responsible for quite 75 per cent. of an amateur's performance on the air. It deserves in consequence a more dignified existence than that of being strung up to a pole that rots off at ground-level or of being tied to something lashed precariously to a tree. In both instances the whole affair is liable to become suddenly airborne during the first gale.

The Foundation

It has always been the writer's experience that whether it is to support a plain mast or to hold up something more massive for the stationary parts of a rotary beam, the only lasting and complete answer is a concrete tabernacle. This particular solution of the problem is of course not the cheapest unless one is prepared to carry through the whole job one's self. But even if a local builder supplied the concrete posts, the digging of a hole and its refilling with concrete to form a substantial butt should, with the help of a second operator, be well within the capabilities of the average amateur. And once fixed, a concrete tabernacle remains as long as the QTH—in fact, should it be decided at a later date to remove the posts to a fresh QTH, a pneumatic drill will probably be needed to loosen the thing!

The job to be described was carried out during the initial scramble to get back on

the air. The sad discovery was quickly made that the two pre-war 40-ft. scaffold-poles had rotted so badly that they were only fit for sawing up into short lengths to support rambler roses. This was accordingly done and there then followed the apparently hopeless task of finding new masts. After prolonged search a larch and a pine were delivered to the site. As the rest of the material required was readily obtainable outside the Black Market, the remainder of the job was put straight in hand.

The sketches and description of how the work was carried out cover one tabernacle only, and can of course be multiplied when and where necessary.

Owing to domestic commitments it was decided to entrust a local builder with the making of the concrete posts, and these he described as being "8 ft × 6 in. × 5 in. and made of reinforced concrete (1:2:4 mix of portland cement, washed sand and washed and graded $\frac{3}{4}$ -in. aggregate), each post reinforced with four $\frac{3}{8}$ -in. mild steel rods and complete with pipe-barrels for bolt-holes." It should be mentioned that without reinforcing rods running the whole length of the posts, they have been known to snap off like rotten carrots.

Preliminary Work

While waiting for delivery of the posts a hole 3 ft. deep and 2 ft. square was dug, the soil and gravel taken out being scattered in odd corners of the garden. The butt of the particular mast to be held between the two concrete posts of this first tabernacle was then measured and, making due allowance for sufficient play in raising and lowering the mast, two $\frac{1}{2}$ -in. black iron rods with threads, nuts and washers were obtained. These measured 20 in., a length unobtainable from stock at any builder's merchants, and were made by the blacksmith.

To serve as distance-pieces between the posts while the concrete butt was hardening off, two $6\frac{1}{2}$ -in. lengths of old piping were cut with a hacksaw. Two 1 cwt. bags of cement were obtained from the ironmonger and from a haulage contractor half a cubic yard of ballast (washed gravel and clean sand). Actually, broken bricks from any demolished air-raid shelter mixed with clean sand would have been suitable. To serve as a large plate upon which to mix this packing for the hole, an old sheet of corrugated iron was roughly flattened with a heavy garden-roller.

The concrete posts having arrived from the builder, two were hauled to the edge of the hole into which they were slid and

manœuvred upright. The pipe distance-pieces were held in turn between the posts, the top and bottom bolts slipped through and the nuts tightly spannered up. A plumb-line and spirit-level pronounced the posts to be upright and square, and in order to keep the feet from twisting or splaying, some rough timber distance-pieces rammed between them at the bottom of the hole and also at each side. These were to be left in and not retrieved as the posts had to be kept absolutely rigid while the concrete butt was hardening off, for which a full week was allowed.

The Concrete Butt

The next job was to make up the concrete packing for the hole, and although a mixture by volume of six of ballast to 1 of cement would have served, it was decided to make a stronger one of 3 of ballast to 1 of cement. As the corrugated-iron sheet was not very large, three buckets of dry ballast at a time were thoroughly turned by spade with one bucket of dry cement. This was then again well mixed while water was being added to an amount that made the final result just "loose" enough to slide slowly off the spade.

When carried to the hole into which it was thrown, a rough length of timber was used to ram the mixture between the posts and all round the sides. This process was continued until the entire hole was filled, and as frost was then threatening, some sacking was placed over the surface to avoid the labour becoming completely lost.

Dressing the Mast

During the week in which the concrete butt was hardening off, attention was turned to the mast. Ordinary rope had in the past given trouble through rotting, so a ship's chandler was visited and 100-ft. of log-line purchased. The ironmonger supplied some boiled linseed oil and for additional weatherproofing the log-line was left to soak in it.

Pulleys had also in the past given trouble through jamming and thus necessitating the tedious lowering of the mast to free them. So this time a manger-ring (also known in farming districts as a "ring-bolt") was purchased from the ironmonger. With the mast lying on the ground, its butt towards the concrete posts, this manger-ring was bolted through the head of the mast; a length of log-line was cut and one end threaded through the ring and brought down to within a con-

venient distance from the mast butt. Here it was tied to the other end of the line in order to form an "endless rope" that would be permanently attached to the mast. Instead of having to lower the mast in the event of the aerial line breaking, all that would be necessary to effect a replacement would be to tie a new aerial line to the endless rope and run it up and through the ring till it was returned near enough to the ground to be detached. The aerial could then be tied on and hoisted up again. (See sketch.)

As only a small space was available at the rear of the posts for staying the mast once it was up, it was decided to bolt a king-post 6 ft. down from the mast-head. By this method it would be possible to anchor the guy-wire as close as 3 ft. to the tabernacle and yet still obtain sufficient staying-tension. Two 3-ft. lengths of 2 in. by 1 in. batten were accordingly cut, creosoted and bolted to each side of the mast, while another bolt was put through the batten-ends remote from the mast. A stranded wire clothes-line with rope centre, split up with insulators, made the guy-wire, and after fixing one end of this round the mast-head just below the manger-ring, it was taken down to the king-post, pulled taut, taken for two turns round the batten-bolt and continued down towards the mast butt. Next the remainder of the log-line was threaded through the manger-ring and brought down to the mast butt to form the aerial rope.

A loose rope rides up in wet weather, causing the aerial wire to droop in sympathy; if it is tied to the mast itself, rain can tauten it so much that it will snap. Experience has shown that the best thing is to let the aerial ride up and down with a weight on the rope. This will keep the wire taut.

Raising the Mast

The concrete butt having had its full time for hardening off all that now remained was the actual raising of the mast. Two holes were accordingly drilled through the mast, large enough to take the top and bottom bolts comfortably. The top bolt still in the tabernacle was then removed, its pipe distance-piece pulled away and a short length of rope was tied to the top of the left-hand post, taken round it several times, passed across at the rear to the right-hand post, taken round a few turns and there securely tied. This was to form a stop to keep the mast from toppling over backwards, once it had reached the upright position, as it

DETAILS OF TABERNACLE

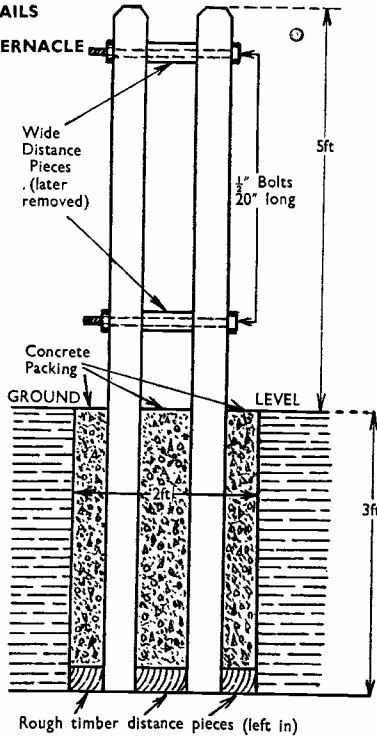

PLAN

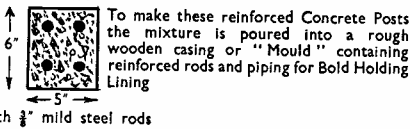

DETAILS OF MAST

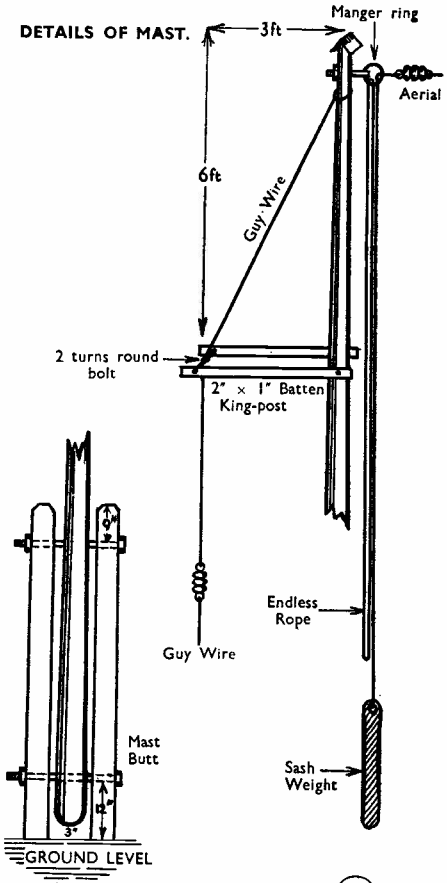

MA
5

would have to be there steadied while the top bolt was being replaced.

The bottom bolt was then removed from the tabernacle, its pipe distance-piece pulled away, the mast butt hauled forward between the posts and lifted upward until the holes registered. The bottom bolt was then replaced to hold the butt of the mast between the posts and the nuts were screwed up.

This bottom bolt formed the fulcrum for raising the mast, which was then heaved off the ground by lifting the mast-head and resting it upon a short pair of house-steps. Walking forward under the mast in the approved "arms upward

stretched" attitude, raised it still higher, and the second operator was then able to take its weight by jamming the top rung of a short ladder under it. A second ladder was then brought into action. By pushing upwards with the front ladder and taking the weight on the rear ladder, the mast was finally vertical and could be worked into its position between the concrete posts, where it was steadied while the top bolt and nuts were being replaced. The guy-wire was anchored, the aerial rope was tied to its insulator, the sash-weight was hung from the free end, the aerial was run up to the horizontal and the two operators sat back and admired their handiwork.

One Watt Can Still Work Wonders !

Experience with QRP on 7 mc

By W. OLIVER (G3XT)

(Pre-war readers will remember G3XT's exploits with QRPP on 40 metres. He is still at it, with much the same gear, and on the same band. Vive le QRP !—Ed.)

When my licence was re-issued and the G3XT was radiated again on the 7 mc and after seven years of radio silence, I had some misgivings about the chances of a one-watt signal battling its way through the QRM which seemed to be, if possible, worse than it was before the war.

At first my misgivings seemed to be fully justified. True, I made a few contacts, and reports of readability and signal strength were about the same as those used to get in pre-war days with a similar QRP transmitter. (That was the one I described in the August 1939 issue of the *Short Wave Magazine*—and I have been surprised at the number of amateurs who still remember that article.)

Early Set-backs

But on the whole the situation looked far from promising. Many calls were put out to CQ and not a station answered. Dozens of CQ's from other 7 mc stations were replied to by G3XT, but very few contacts resulted.

Then (just to make matters worse !) I caught a QRO 'flu germ and retired to bed with a temperature of RST 103 ! When it subsided a little, the transmitter and receiver were fixed up temporarily in the bedroom and once again G3XT reappeared on 7018 kc—but decidedly *pianissimo*, as my solitary little wattlet was sliding out of the window on an emergency transmitting aerial of ludicrously inefficient characteristics. It consisted of a few feet of insulated wire slung out of the window on to some snow-covered lilac bushes in the garden, with its far end only about four feet from the ground !

Strange to relate, it worked. G6TQ (Tonbridge) reported signals RST 449 peaking to 569, which was remarkable for such a poor serial energised by such an insignificant input. G3AAE (Bournemouth) gave me RST 559 in a 15 minutes' QSO, solid both ways, with QRP at both transmitters and an indoor aerial at his end. G3AAN (Hertford) got me RST 549 despite QRO telephony QRM.

Prior to the break for 'flu, about 250 calls were put out on the normal aerial

during the month of February. These yielded only 13 successful contacts ! The best DX was SM6SB, and the most solid contacts were with G2ASL (Birmingham); G3UY (Guildford); ON4SSM (Brussels); G3AQD (Milford, Surrey); G2YS (Coventry); and G3AWA (Beckenham). Some of these QSO's were held for up to 35 and 40 minutes, with RST's obtained averaging 559.

A return to the normal aerial and a new HT battery to boost up the input a little (it had fallen below the one watt, but with the new HTB came up to about one-and-a-half), resulted in a marked improvement. G6TQ announced that my signals had bounced up to RST 579 down in Kent. From then on the number of contacts began steadily to increase, and reports got better, too.

Recent Results

On several days lately, 30 to 50 per cent. of the calls put out from G3XT have resulted in successful QSO's. Considering the number of stations now crowded into the 7 mc band, and the high power that is used by so many amateurs nowadays, these results are decidedly encouraging.

A summary of one week's activities recently shows some 40 stations worked, mainly G's and near Europeans, with powers up to 100 watts in use at the other end of some of these contacts, and RST's varying from 559 to 579 given me.

Admittedly there is no startling DX ; but the reassuring fact—for those who, like myself, may have doubts about the possibilities of QRP on the post-war 7 mc band—is that most of the QSO's were 100 per cent. solid copy ; some of them were maintained for half an hour, an hour, or even more. Few operators had to ask for repeats ; I seldom had to send anything QSZ except the RST and QTH, which it is customary to repeat anyway ; and in nearly every case I was able to get perfect copy in ink of the other station's remarks, even when they too were QRP ; no pencil scrawls and guesswork, but block letters with a fountain pen !

Telephony transmissions, with over-

deep modulation, too much power and verbose operators, made things very difficult at times, but we managed somehow!

QRP Worth Trying

Perhaps these results will give a little encouragement to those who, for various reasons, cannot run a high-power transmitter, or who wishing to try QRP for its own sake, have been disheartened by blood-curdling stories of the QRM on 7 mc.

Moreover, the foregoing details of solid contacts with this one-watt CO/PA battery-powered transmitter (actually using the self-same valves from the pre-war version, tenderly cared for by the GPO Engineering Department through six years of war) and with a home-built O-V-2 receiver of somewhat rough-and-ready construction, may shake up some of the QRO enthusiasts who believe that at least 25 watts and an 8-valve superhet receiver are essential to maintain communication on the much-maligned 7 mc band. Vive le QRP!

Simplified Coverage Calculations

Getting Quickly at C and L

By K. E. MARCUS

Wave band coverages are usually calculated with the help of abacs. The writer having experienced the limitations of this procedure has developed a purely mathematical system of calculation, which he has used extensively over a number of years and which is explained here for the benefit of his fellow-sufferers.

The fundamental formula for resonance

$$LC = \frac{1}{\omega^2}$$

can be modified (for L in μH , C in μF , f in mc) as follows:

$$LC = \left(\frac{159}{f}\right)^2$$

and as most of the calculating required is based thereon, he has introduced a "mathematical shorthand" symbol, \underline{C} :

$$\underline{C} f \text{ (read: "the LC value of f")} = \left(\frac{159}{f}\right)^2$$

Each frequency has its own LC value and it is quite easy to evaluate them one by one and tabulate them.

Now, assuming we have to calculate the coverage for the 10-metre amateur band, i.e. 28 to 30 mc, we write:

$$\begin{aligned} \underline{C}28 &= (\text{antilog } 2(2.2014 - 1.4472)) \\ &= \text{antilog } 1.5084 = 32.2 \end{aligned}$$

$$\begin{aligned} \underline{C}30 &= (\text{antilog } 2(2.2014 - 1.4771)) \\ &= \text{antilog } 1.4486 = 28.1 \end{aligned}$$

or, in plain words: to tune from 28 to 30 mc we have to make the LC value change from 28.1 at the high frequency end

to 32.2 at the low frequency end, i.e. by 4.10.

Let us further assume that we intend to employ capacitive tuning using a variable condenser of 10 μF variation. Then, obviously, the change of LC value by 4.1 is to be achieved by varying C at the rate of 10 μF , which gives us the value of 0.41 μH for L.

Now, at the high frequency end the required LC value is 28.1. With 0.41 μH for L the total initial parallel capacity is clearly indicated with about 70 μF . As the strays, valve input capacities and such like will sum up to about 30 μF , a trimmer of 50 μF maximum will be required.

To check the scope of the method let us see where we would have got to if we intended originally to use a tuning condenser of 25 μF variation. Then $\frac{4.1}{25} = 0.16$, i.e. our inductance becomes

0.16 μH and $\frac{28.1}{0.16} = 175$, i.e. our trimmer becomes about 150 μF . Evidently a circuit of these constants has a considerably lower Q than the one calculated in the first place.

Again, with a capacity of 3 μF variation: $\frac{4.1}{3} = 1.4$ μH inductance, $\frac{28.1}{1.4} = 20$ μF total initial capacity, which can be surmised as not obtainable.

As can be seen, the procedure is quite simple and very quickly performed as soon as one has got the hang of it. Additionally, it is much more exact than the abac method.

Keying and Metering System

Circuit for Economy and Flexibility

By A. G. SUTTON (G3ADH)

A feature of the amateur's make-up is that sooner or later he is left with one or more pet theories which he is, in the main, most reluctant to forgo. One cannot but admire this diehard spirit which so often has led to learned and not unlively debate, and on occasion, perhaps, to a change of outlook in which cherished and time-honoured procedure has been laid aside to be replaced by a new and sometimes a strange technique.

Keying practice figures very largely in this matter of individual preference. Yet it is oddly true that metering systems, particularly, do not arouse nearly as much interest. Metering, it would seem, is a problem that is commonly left to solve itself—a vacant spot is discovered somewhere on the panel or on the Tx assembly—and in goes a meter, which is then wired, switched and generally adapted to the Tx layout much as if it were an unwelcome but unavoidable addition to an otherwise normal scheme of things.

Tidying Up

When much patient planning has gone to an otherwise excellent Tx design, why should not this worthy component be given the respect and consideration which it certainly deserves?

With a new transmitter under construction, a critical survey was made of the circuit, with the gratifying result that the keying and metering systems have, in the interests of simplicity, flexibility, efficiency and economy, been thoroughly streamlined.

Although there is nothing new in this particular arrangement, it offers a ready-made solution to keying and metering problems and caters for the foibles of the pet theorist and for those who are more adventurously inclined.

Circuit

A glance at the circuit here will show that any stage, or combination of stages, may be keyed and/or metered by the simple insertion of a key or shorting plug in the appropriate jack. A second glance at this circuit will reveal that it has many possibilities.

Since VFO's are now so much in vogue, it is often necessary to provide for keying in more than one stage. It is in any case desirable to arrange matters so that keying can be applied at a number of different positions.

The same arguments apply to stage metering: It might be interesting to read the anode current of the VFO; it is accepted practice to read that of the CO and buffer stages; and of course, a rather serious default not to sample the juice in the last bottle.

Thus one may have any number of stages on tap, either singly or otherwise, without the inherent drawbacks of complicated switching, intricate wiring, circuit losses and panel spoiling.

Only a few of the more obvious uses to which this flexible arrangement may be put have been listed below, and although cathode keying serves as an illustration, the idea may easily be adapted to any other type of keying.

(1) Insert key at jack A to key the oscillator.

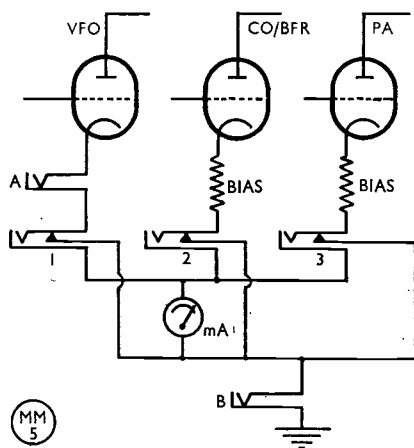

G3ADH's circuit for meter switching and keying. A shorting plug in jacks 1, 2 or 3 as required will produce plate current readings on the meter for the appropriate stage. Keying can be effected at either jacks A or B.

(2) Insert key at B for simultaneous keying.

(3) Any one stage may be keyed and metered by inserting the key at jacks 1, 2 or 3, as required.

(4) Any stage may be metered by inserting shorting plugs at jacks 1, 2 or 3, when keying may be done in the oscillator stage (jack A) or simultaneously at jack B.

(5) Stages may be metered simultaneously by inserting shorting plugs at jacks 1, 2 and 3, when keying may be carried out at any stage by inserting the key in place of any one shorting plug—simultaneous keying is then done at jack B.

(6) By partially inserting a shorting plug in jacks 1, 2 or 3, the cathode circuit is broken and a stage may thus be cut off for test or other purposes.

(7) By inserting the key at jack B (with the key up), the anode current to all stages may be cut for test or warming-up purposes.

(8) When the transmitter is not in use the meter can be employed for ordinary test purposes by insertion of a plug in any of the jacks 1, 2, 3 and in jack B, with a single lead from each taken to a pair of test prods or a test panel. These plugs must be wired to connect with the meter when they are inserted.

THE AMATEUR BANDS

Following are the bands now open for British amateur operation :

1715-2000 kc	10 watts (A) and (B)	
3500-3635 kc } 3685-3800 kc }	25 watts (A), 150 watts (B)	
7000-7300 kc	25 watts (A), 150 watts (B)	150
14000-14400 kc	25 watts (A), 150 watts (B)	150
*28000-30000 kc	25 watts (A), 150 watts (B)	150
*58500-60000 kc	25 watts (A) and (B)	
460.5 mc	5 watts (for radio control of models and only by special application)	
*2300-2450 mc	25 watts (A) and (B) *FM permitted.	

"A" licenses are all three-letter calls issued post-war, and are for CW operation only; licensees in this category are not normally allowed the use of telephony and full power till they have had twelve months' experience. Class "B" licensees are holders of reissued pre-war two-letter call signs, and are allowed the unrestricted use of CW, MCW and 'phone with power as given above.

"NICE WORK"

The paragraph under this heading in February issue (p. 760) brought us comments from several readers. It seems that G8JB (Havant, Hants) was also in on the traffic with SU1VL (not GL as given by G2AXG) and that he too QSP'd the message to the Edinburgh police. The local press reported the facts following a visit to G8JB.

Other correspondents wish to know if such traffic is strictly legal. Within the intended meaning of Section 8(2) of the Licence, it probably is not. But the test in such an instance becomes a question of expediency, and it is very much to be doubted whether in the circumstances the parties involved would have been justified in refusing the traffic, let alone questioning whether it should be accepted. However, since the intention of Section 8(2) is to prevent third-party message passing, it is obvious that in general operators risk trouble by accepting traffic not directly concerning either end of the contact, and so should avoid doing so.

This is neither a ruling nor a judgment—merely our own opinion upon what actually happened in this particular case.

The Editor Wants

- ★ Photographs with Notes for the "Other Man's Station" series.
- ★ Photographs of Equipment of Amateur Radio interest, home and overseas.
- ★ Photographs of Club Meetings.

All material accepted for publication is paid for on appearance. Photographs must be clear and sharp, but can be any size, and either print or negative. They can be returned if required; the block-making process involves no damage.

DX COMMENTARY

ON CALLS HEARD, WORKED & QSL'd

By L. H. THOMAS, M.B.E. (G6QB)

Even a crisis can be turned to advantage! As last month's late appearance means that very little correspondence has yet arrived, the opportunity occurs of doing what we have had in mind for some time—to write a "DX Commentary" on our own. There are many things we want to say and quite a lot we should like to know; and, at last, here is the time and the space. But let no one feel letters on DX matters will not be welcome after this spasm is over! We couldn't write the column every month, and anyway it is primarily a readers' feature.

The DX bands have all been doing their stuff, more or less as predicted, except that a couple of sunspot fade-outs have been rather more serious than usual. The one at the beginning of March put the 28 mc band *right* out for the first time that we can recall since about last August; then, when the second half of the ARRL Contest came along, 28 mc was out for USA until the Sunday afternoon, when the W's suddenly started pouring in. It seems we are going to have these disturbed periods that most of us will remember well from pre-war days; DX apparently not good, but, when you look into it, not so bad. The bands sound dead because no W's are coming through, but turn out to be open for South America, Central America, West Indies, sometimes W4, and, at the appropriate time, for practically everything in Asia.

There are still some people for whom "no Yanks" means "no DX"—but they'll earn.

28 mc DX

Various interesting things have happened on 28 mc. For one thing, the conditions are more or less reflecting what occurred last year. This means that in the mornings we are liable to find things good for Guam, Okinawa, possibly Hawaii and so on, before the VK's begin to arrive. We first woke up to this when we nearly passed over an S7 'phone which turned out to be W6ONP/KW6 on Midway. During the QSO which followed, it was most difficult to convince him that he really *was* having a genuine G contact. Later on the band filled with VK's.

Now here's one point upon which we should like to be enlightened. What is the precise difference in conditions between two consecutive mornings, one of which brings in nearly all VK's, and the next ZL's, but with our friend VK5NR in North Australia S9 in the middle of them? Noel of VK5NR is seldom heard when the rest of the VK's are good; this may be reasonable, because he is some 600 miles nearer than any of the others. But why should he arrive on "ZL days"? And the "ZL days" are certainly more interesting than the others, because a little extra rooting around will generally disclose VR2, ZK1 and even FK8 in the background.

You wouldn't believe it unless you had a great circle map, but there is 90 deg. difference between the paths to ZK1 (Cook Islands) and New Zealand, although, as we all know, they are not far apart. Cook Islands are North West from London, whereas New Zealand is North East; the distance of Cook Islands, however, corresponds to that of Melbourne rather than to that of Auckland. Why, then, are they never heard except when the ZL's are coming through?

While we are on this subject, there is another interesting point which we have noticed so often that it cannot possibly be a coincidence. This is the way the different parts of North America come in on a *normal* 28 mc afternoon. After mid-day the band is full of W1's and 2's. Then there is an interval for lunch, after which one is liable to find 3's, 8's, 9's and possibly 0's added. By about 1430 GMT (mid-March) the first Californians (6's) have arrived. All districts (7's and 5's being the rarest) are audible through most of the afternoon.

Then comes the interesting moment. The East Coast stations fade out, leaving the 6's and 7's as the best signals; but the moment they begin to weaken one hears VE1's arriving. Seldom W1's, but *always* VE1's. This leads one to suppose that the "first hop," all the afternoon, has been dropping into the Atlantic, but



Clearly, VE3BKL of Merriton, Ontario, has practically 'everything'! The transmitter is a BC-610 running just the half-kilowatt input, and receivers are a Super Pro and SX-28A.

eventually lengthens sufficiently to reach Canada, although the strength of the VE1's on these occasions is hardly great enough to support that theory.

Of course, during the various abnormal afternoons all sorts of funny things may happen. Sometimes we have a Texas party, with nothing audible at all except W5's in that State. Other days we have a West Indies show, with VP6YB, the Porto Ricans and probably W4's in Florida only. And, most fascinating of all, we seem to get a set of conditions that mean good reception of the West Coast but *not* of California. Then we find the 'phone band full of W7's, with a few VE7's and VE6's also arriving, and the W6's though present, are weak.

It seems to us that one or two keen types who can work 28 mc every afternoon and are prepared to plot a series of charts or graphs might be able to help a lot in correlating present information with the sunspot data that is available. Such a task would be laborious but definitely more interesting than plotting the acreage of QSL's on the wall against CQ's sent out.

14 mc DX

It is much more difficult trying to make any sense out of 14 mc, as the conditions obtaining there seem far more complex.

One never knows what is going to happen in the afternoons and early evenings, as anything from W1's to VS6's may turn up quite early in the afternoon; then one can get back from a tea interval to find ZL's and VE's on the band! Recent freak happenings noticed have been the appearance of KA6FA (Philippines) at S7 after midnight, and CX4FB (Uruguay) quite early in the evening.

No, the man who can make sense out of 14 mc conditions is either extremely clever or stark, staring crazy. We certainly don't know a band more calculated to make one hopping mad, if only for the commercial pirates who frequently crowd the LF end. The day before writing this (late March) there were seven strong ones between 14000 and 14080, and they were *not* images. Of these seven, only two were doing anything that might have been useful—the other five were just "occupying the channel" with dots or V's, three of them signing Russian call-signs and the others not identifying themselves at all. When are we amateurs going to get a fair deal in this matter? One of us goes off frequency with 15 watts and the balloon goes up right away; but umpteenth commercials can "pirate" our bands for months on end and nothing can be done. "It's the rich wot gets the pleasure . . ."

And when are the CW boys going to

make some use of the 14300-14400 region? There is practically no commercial piracy up there, and very few 'phones operate above 14300—why not do something about it? In pre-war days, when the American 'phone band was definitely and permanently in the middle, there was rather more of a DX party on the 14400 kc edge than at the LF edge, but those days don't seem to have returned. We distinctly remember our 14380 crystal (there were tolerances then) and the number of W6's and things it had chalked up to its credit. Let's get weaving at that end, and quickly. It only needs someone to start.

7 mc

The DX is still there, but what a mess! We have given up binding about 7 mc 'phone, because it is obvious that it will always be with us; but until there is a clearly defined 'phone section, 7 mc will remain a slice of chaos. Personally, we don't see why anyone should bother to wrinkle out the DX on 7—why not call it a local 'phone band and have done with it? There's plenty more room on 28 for CW, although we don't quite see how it's going to pan out when the new American partitioning of the band comes into force; but on certain days 7 mc sounds as if one more signal, 'phone or CW, would burst the whole band open. The fact of the matter is that there is far too much use of 150 watts for inter-G 'phone, working; everything would run more smoothly if we voluntarily restricted ourselves to 25 watts. But it is obvious how the reasoning goes—the average amateur says, "What chance have I of breaking through with low power if all these other guys continue to use 150 watts? And I'm licensed for 150 and have the gear, so why not let it rip?" And he does.

Without interfering with anyone else's pleasure in the least, we would very much like to see a 25-watt limit on 7 mc, because we feel that everyone would eventually benefit from it. (Yes, we are open to receive brickbats and all others kind of irregularly-shaped missiles, but by *post*, please!)

Worked All Zones—or How Many?

Having committed all that to the public judgment, and feeling better for it, there are certain other matters with which to deal. First, WAZ. You will find the list of zones in this issue. We want to publish a monthly WAZ credit list as we are accepting G claims for WAZ, not only on our own behalf, but for parallel publication in the American journal *CQ*, the origina-

tors of this particular scheme.

Cards will not be required in substantiation until an actual "WAZ" (Worked All Zones) claim comes up. For the moment, unless you are fortunate enough to be able to claim this, just forward your score as "W 38 Z" or "W 30 Z" or whatever it is, adding your number of countries and zones confirmed as well. We propose to keep the whole thing on a post-war basis. Let bygones be bygones!

The WAZ listings will be published in a bold-face panel each month, and the number of applicants will decide how far down in numbers we can go. (If a hundred or more G stations claim 38 Zones, it won't be very far!) Obviously, it is necessary to see some claims before the datum point can be fixed. But remember that you cannot claim to have Worked All Zones until you can submit the cards in confirmation.

WORKED ALL ZONES LISTING

If you have worked 30 or more Zones, send in a claim for listing in "DX Commentary." Claims listed will be republished in *CQ*'s "W.A.Z. Honour Roll." Documentary proof is not required, but the number of Zones from which QSL's have been received should be stated. Mention also Zones not yet worked.

And now for the correspondence. VE3QB is one of our regular Canadian readers, and passes along a few tit-bits. He says VE8ME, 8MF, 8MQ, 8MT and 8NW are all at Clyde River, Baffin; QSL via VE3QB, Lanark, Ontario, but don't expect return cards until late in 1947, as there may not be any mail out until then. '3QB wants some reliable reports on his signals, but this is a SWL matter and has been passed to the *Short Wave Listener*. Incidentally he remarks that he is on a farm, and makes maple syrup, and doesn't expect reports for nothing! Look for VE3QB (strictly for QSO purposes) on 28236, 28346 and 28372 kc.

G3BGS (Kidlington) reports all the funny ones, including YO5WM, OERJ, PIIL (QTH The Hague) and CT2WX, who is believed to be genuine in the Azores. OI2KAF and OI2KAL are Finnish—all open and above board. G2VV (Hampton-on-Thames) worked YO5WZ, who said this prefix is allowed

by the Roumanians. A mobile maritime worked by G2VV is W8QOH/MM (s.s. *Delmando*), in the PZ area. Another is W5BSY/MM (s.s. *Crest of the Wave*), off the Azores.

XABX (Athens) mentions the trials of the XA's out there nowadays. They have only German scrap from which to build their rigs—and the boneyards do contain real scrap and nothing else, nowadays. XABX uses a 6½-watt German tank set on which the QRO button gives an input of 10 watts. He asks us to pass on the word to some of the G's to strain their ears a bit and listen for such small fry in among the BC-610's.

GM3AWO (Dundee) recently heard TA1C working the States, but suggests that the "Turk's" QTH is probably Dundee from the sound of him. . . . G5PO (Wirral) thinks his call is being pirated, but sends all the non-checking QSL's back instead of saving them for the pirate. . . . "Pop" Jennings, G6AW, is returning to civilian life and a new QTH at Herne Bay. He will be grateful for any reports, and says "Goodbye and thanks very much for all your help" to the group in the Reading, Slough, Maidenhead area, compared with which his new line of country seems a little lonely.

VU7JU (Bahrein) is now on the air, and although his aerial is not yet hauled up, he has worked a few G's and some other DX. His QTH is S. G. Abbott, Officers' Mess, RAF Bahrein, Persian Gulf, and he will QSL to everyone in due course, when his cards arrive from home. He runs 35-40 watts of CW on 14 and 28 mc, and hopes to be on every day at times suitable or G QSO's.



The outfit at W1CPL, Wakefield, Rhode Island. Ships and aircraft seem to be a side-interest.

Last month's "GEZAA" episode (see p. 30) is explained! GEZAA is the RAF call for "any British aircraft," but some enthusiastic aircrew W/Ops decided to use it from the ground! They were detected and swift justice followed; from what we gather it is doubtful whether their T1154 will be heard again on the amateur bands.

G8KP (Wakefield) has worked more than 120 countries (post-war) to date, and all on 14 mc. Nice-looking ones from a long list he sends include HH2BL, VS2BJ, CM2SW, HZ3AB, NY4CM, ZC1AN, PK4KS, KP4CJ, VQ5JTW—in fact, pretty well everything going. He came on in the ARRL Contest—"just for fun"—and in the first half worked 172 stations in 13 districts on 14 mc

only. Now he is after South Dakota for his W.A.S.

G3ATH/XZ (S/L Pain, late of ZB2A) should be on the air very shortly, and would welcome a line from any of his friends. His present QTH is Area Control Centre, AHQ Burma, SEAAF. G2HNC (Wirral), writing after being on the air just a week, announces that he is a band-planning fan already! He wants to know whether any cards are getting through from the various Russian districts—as far as we know, they are not bad.

G6BB (Streatham) is playing with a closed-spaced rotary on 28 mc now, and finds he can break through the QRM right up to the time of fade-out. On 14 mc he has also been doing some good stuff including VE6 and W6AWA/KH6. G3BBA (Towcester), who asks for information about CT2XA because an S9 report seems too good from an S5 direction, is a staunch advocate of band-planning and also suggests that a little less QRO is one of the main requirements nowadays. He would like to see more use of BKS, with which he is quite familiar from his RAF days, and wants to hear more T9 notes—even if they do come from VFO's. It can be done, as he has found for himself.

Transmitting readers are invited to send items for DX Commentary to L. H. Thomas, G6QB, "The Short Wave Magazine," 49 Victoria Street, London, S.W.1, to reach him as early as possible in the month. SWL reports are only included in DX Commentary if they are of direct interest to transmitters.

Peter Keller of XADZ is home on leave about now, and probably on the air as G3AXU. He is another BKS enthusiast, and recently spent a whole Sunday calling "CQ BKS" on 'phone—with quite a number of replies, mostly from Continentals. As he says, one of the chief nuisances of single-channel working is that the newcomer, having shifted to one spot for a QSO, then stays there and jams his last contact while he makes his next one. He advocates one or two chosen frequencies (crystal or VFO) to which to return after shifting for a single-channel QSO. This combines the merits of both systems in that it establishes a setting where one may be looked for by old friends. Personally we use a crystal for all CQ calls and only shift on to VFO to collect some of the elusive bits; if we can persuade them,

CALLS HEARD

The Calls Heard page lists mainly G's heard overseas on the DX bands, as well as on 1.7 and 58 mc at shorter ranges. Overseas readers are particularly invited to send in such lists, covering reception of G's on all amateur bands.

having once made contact, to follow us up to the crystal frequency, we do that, too.

G3AXU concludes with a story of a QSO with HB9KF, which went off without incident until his card arrived from Budapest—open, through the post, bearing his Hungarian SWL number and details of his transmitter.

G5GK (Burnley) says that conditions have been quiet on 7 mc this month, but that during the ARRL Contest he got 180 contacts; DX included HH, KZ PY, VP9 and VE1-4, which is an excellent showing. G2JB (New Malden) comes up on the Windom question and says that he has always been able to check for standing waves; he has found that the radiation pattern and general behaviour of his Windom was in conformity with theory.

That concludes this month's rather thin layer of correspondence. There are no DX QTH's and very few Calls Heard, but next month we hope to settle down once more to the old routine. All letters, Calls Heard, brickbats (and compliments, if any) will be wanted by first post on April 16, please. Meanwhile, as usual, good hunting—and think seriously about ABCC.

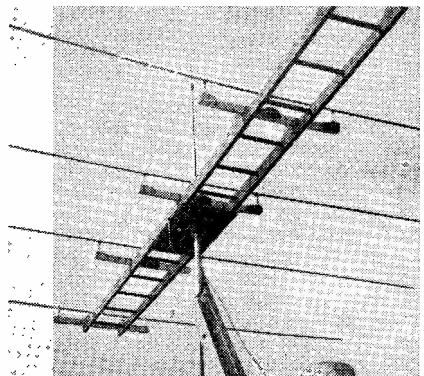

Construction of a rotary beam. A ladder is used to carry the five elements of the 28 mc job at G4AJ, Basingstoke. The pipe mast, supported on bearings, rotates the structure.

DX FORECAST FOR APRIL 1947 (All Times GMT)

	7 mc	14 mc	28 mc
NORTH AMERICA :			
East and Central	2330-0700	1500-0900	1200-2100
West Coast	0400-0900	0500-1000	1500-1900
CENTRAL AND SOUTH AMERICA	2200-0300	2300-0500	0900-2200
AFRICA :			
North of Cancer	All day	All day	0900-1700
South of Cancer	1500-2200	1400-2300	1100-2100
ASIA :			
West of 75° E.	1500-2100	1400-2200	0900-1500
East of 75° E.	1500-2000	1300-2000	1000-1300
OCEANIA :			
VK, ZL, VR, ZK	1500-2100 0730-1000 1800-2200	0800-1600	1000-1300
PK, KA, KG6, etc.		1300-2200	1000-1300

NOTE.—The times given above are the most likely periods during which signals may be expected from the parts of the world indicated. Under unusual conditions, signals may be heard outside these times.

AMERICAN VALVE RATINGS

From *QST*, we extract the following data, produced by the R.C.A., on the ratings of receiving valves in low-power transmitting service. Only the main details for the types readily obtainable over here are included, the order of the figures being the maximum plate voltage, screen voltage, negative bias, plate current, grid drive and RF power output; the upper frequency limit in each case is 10 mc at these ratings.

6F6 400, 275, -100, 50 mA, 5 mA, 14 watts.

6L6 400, 300, -125, 100 mA, 5 mA, 28 watts.

6N7 350, -100, 30 mA per plate 5 mA per grid, 7 watts per plate.

6V6GT 350, 250, -100, 47 mA, 5 mA, 11 watts.

"YOU AND WHO ELSE?"

Under this heading, February *QST* rightly draws attention to the fatuous and irritating habit of some 'phones who use the word "we" when they mean "I". For a single-handed station to adopt the royal plural (which is also an editorial prerogative when speaking for the paper or its

policy) is arrant nonsense, and against all rules of spoken English.

It would be well for the prestige of Amateur Radio in this country if some of the 'phones did try and speak English, rather than the idiotic jargon adopted by many operators—and not all of them youngsters.

And if ever you give a hack reporter a story about Amateur Radio, steer him away from our CW language, which does *not* look well in the public print.

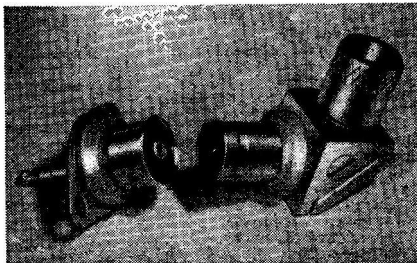

The new Belling-Lee co-axial plug and socket, taking up to $\frac{1}{2}$ in. cable. The action is "snap" and the screen covering of the lead is held without soldering